

## INDICE

• AUTORIZZAZIONE PUBBLICITA' (AREA 3- POLIZIA MUNICIPALE -)	PAG. 2
• RICORSI (AREA 3 – POLIZIA MUNICIPALE)	PAG. 3
• ACCERTAMENTI AMMINISTRATIVI CDS (AREA 3 – POLIZIA MUNICIPALE)	PAG. 4
• RIMBORSI (AREA 3 – POLIZIA MUNICIPALE)	PAG. 5
• PUBBLICITA FONICA (AREA 3 – POLIZIA MUNICIPALE)	PAG. 6
• CONTRASSEGNI INVALIDI (AREA 3 – POLIZIA MUNICIPALE)	PAG. 7
• AUTORIZZAZIONE VENDITA TIPO B (AREA 3 – POLIZIA MUNICIPALE)	PAG. 8
• CONCESSIONI PERMANENTI SUOLO PUBBLICO (AREA 3 – POLIZIA MUNICIPALE)	PAG.9
• MEDIA STRUTTURA (AREA 3 – POLIZIA MUNICIPALE)	PAG. 10
• ORDINANZA INGIUNZIONE (AREA 3 – POLIZIA MUNICIPALE)	PAG. 11
• APERTURA SALA GIOCHI (AREA 3 – POLIZIA MUNICIPALE)	PAG. 12
• APERTURA PUBBLICO ESERCIZIO (AREA 3 – POLIZIA MUNICIPALE)	PAG. 13
• AGIBILITA' LOCALI DI PUBBLICO SPETTACOLO E IMP. SPORTIVI (AREA 3 – POLIZIA MUNICIPALE)	PAG. 14
• SPETTACOLI VIAGGIANTI (AREA 3 – POLIZIA MUNICIPALE)	PAG. 15
• RILASCIO CODICE IDENTIFICATIVO GIOSTRE (AREA 3 – POLIZIA MUNICIPALE)	PAG. 16
• REVOCA, DECADENZA CHIUSURA (AREA 3 – POLIZIA MUNICIPALE)	PAG. 17
• GESTIONE CASSA ECONOMALE, PICCOLE SPESE (AREA 1 – FINANZIARIA Dott. Rosario Sacco)	PAG. 18
• MUTUI (AREA 1 – FINANZIARIA Dott. Rosario Sacco)	PAG. 19
• RENDICONTO TRIMESTRALE (AREA 1 – FINANZIARIA Dott. Rosario Sacco)	PAG. 20
• FATTURAZIONE ELETTRONICA (AREA 1 – FINANZIARIA Dott. Rosario Sacco)	PAG. 21
• MODELLO F24EP (AREA 1 – FINANZIARIA Dott. Rosario Sacco)	PAG. 22
• PAGAMENTO FATTURE (AREA 1 – FINANZIARIA Dott. Rosario Sacco)	PAG. 23
• AUTORIZZAZIONE OCCUPAZIONE SUOLO PUBBLICO PERMANENTE (AREA 1 – TRIBUTI)	PAG. 24
• RIMBORSO ICI IMU (AREA 1 –TRIBUTI)	PAG. 25
• VERIFICA ELUSIONE ICI IMU (AREA – TRIBUTI)	PAG. 26
• APPLICAZIONE AGEVOLAZIONI ISEE PER MENSA SCOLASTICA (AREA 1 – FINANZIARIA - Dott. Rosario Sacco)	PAG. 27
• ASSEGNAZIONE CONTRIBUTO COMUNALE ALLE FAMIGLIE PER ASILO NIDO (AREA 1 – Dott. Luca Costantini)	PAG. 28
• ASSEGNAZIONE ED EROGAZIONE FONDI FIMI E ASLO DELLA REGIONE (AREA 1 – Dott. Luca Costantini)	PAG. 29
• ASSEGNAZIONE ALLOGGI ERPS (AREA 1 – Dott. Luca Costantini)	PAG. 30
• BANDO ASSEGNAZIONE ALLOGGI ERPS (AREA 1 – Dott. Luca Costantini)	PAG. 31
• CONCESSIONI CONTRIBUTI ALLE ASSOCIAZIONI (AREA 1 – Dott. Luca Costantini)	PAG. 32
• EROGAZIONE CONTRIBUTO PER IL SOSTEGNO DELLA LOCAZIONE ALLA REGIONE(AREA 1 – Dott. Luca Costantini)	PAG. 33
• RIDUZIONE ESENZIONE RETTE ASILO NIDO (AREA 1 – Dott. Luca Costantini)	PAG. 34
• SELEZIONE PARTECIPANTI A PROGETTO SOSTEGNO DEL REDDITO (AREA 1 – Dott. Luca Costantini)	PAG. 35
• ASSUNZIONE PER MOBILITA' (AREA 1 – PERSONALE)	PAG. 36
• ASSUNZIONE PER PUBBLICO CONCORSO (AREA 1 – PERSONALE)	PAG. 37
• ASSUNZIONE CENTRO PER L'IMPIEGO ( AREA 1 – PERSONALE)	PAG. 38
• ATTRIBUZIONE PROGRESSIONE ORIZZONTALE (AREA 1 – PERSONALE)	PAG. 39
• INDIVIDUAZIONE SEGRETARIO COMUNALE	PAG. 40
• ACQUISIZIONE CITTADINANZA ITALIANA (AREA 1 – DEMOGRAFICO)	PAG. 41
• CONCESSIONI (AREA 1 – SEGRETERIA)	PAG. 42
• CONTRATTI (AREA 1 – SEGRETERIA)	PAG. 43
• LOCAZIONE (AREA 1 – SEGRETERIA)	PAG. 44
• CONTRIBUTI (AREA 1 – CULTURA)	PAG. 45
• PROCEDURA NEGOZIATA (TUTTI)	PAG.46
• AFFIDAMENTO PER FORNITURE SOTTO I 40.000,00 € (AREA 2 – TECNICA)	PAG.47
• APPROVAZIONE SAL (AREA 2 – TECNICA)	PAG.48
• FORMAZIONE E VARIANTE PRGC (AREA 2 – TECNICA)	PAG. 49
• PROCEDURA APERTA (AREA 2 – TECNICA)	PAG. 50
• PROCEDURA RISTRETTA (AREA 2 – TECNICA)	PAG. 51
• PROCEDURA SOPRA SOGLIA (AREA 2 – TECNICA)	PAG. 52

• ORDINANZE CIRCOLAZIONE STRADALE TEMPORANEE E PERMANENTI (AREA POLIZIA MUNICIPALE)	_____	PAG. 53
• PROCEDIMENTO SUAP AUTOMATIZZATO – MEDIANTE SCIA (AREA POLIZIA MUNICIPALE)	_____	PAG. 54
• PROCEDIMENTO SUAP ORDINARIO (AREA POLIZIA MUNICIPALE)	_____	PAG. 55
• PROCEDIMENTO SUAP – PROCEDIMENTO UNICO MEDIANTE CONFERENZA DEI SERVIZI (AREA P. M.)	_____	PAG. 56
• PROCEDIMENTO SUAP – 6 – PROCEDIMENTO AUA – AUTORIZZAZIONE UNICA AMBIENTALE (AREA P. M.)	_____	PAG. 57
• AUTORIZZAZIONI INSTALLAZIONE IMPIANTI PUBBLICITARI (AREA P. M.)	_____	PAG. 58
• EMANAZIONE ORDINANZE DIRIGENZIALI (D.LGS 152/06 E L. 447/95 – ART. 107 D.LGS. 267/00) (AREA P. M.)	_____	PAG. 59
• RISPOSTE A ISTANZE DI PRIVATI O DI UFFICI PUBBLICI ATTINENTI LE ATTIVITA' COMMERCIALI (AREA P. M.)	_____	PAG. 60
• RISCONTRI E RICHIESTE DI ACCESSO AD ATTI DI ATTIVITA' DI VIDEOSORVEGLIANZA (AREA P. M.)	_____	PAG. 61
• GESTIONE ATTIVITA' STRAGIUDIZIALE SANATORIA E RELATIVO CONTENZIOSO (AREA P. M.)	_____	PAG. 62
• ACCERTAMENTI AMMINISTRATIVI CDS E NOTIFICAZIONI (AREA P. M.)	_____	PAG. 63
• NOTIFICAZIONE ATTI (AREA P. M.)	_____	PAG. 64
• RSISPOSTE AD ESPOSTI E ISTANZE (AREA P. M.)	_____	PAG. 65
• LIQUIDAZIONE SPESE DI GIUSTIZIA ED ALTRI RIMBORSI (AREA P. M.)	_____	PAG. 66
• ACCESSO ATTI SINISTRI STRADALI (AREA P. M.)	_____	PAG. 67
• AUTORIZZAZIONI PUBBLICITA' FONICA E VOLANTINAGGIO (AREA P. M.)	_____	PAG. 68
• RILASCIO CONTRASSEGNI SOSTA DISABILI (AREA P. M.)	_____	PAG. 69
• ORDINANZE TRATTAMENTO SANITARIO OBBLIGATORIO (AREA P. M.)	_____	PAG. 70
• COMMERCIO SU AREE PUBBLICHE IN FORMA ITINERANTE (INIZIO ATTIVITA') (AREA P. M.)	_____	PAG. 71
• COMMERCIO SU AREE PUBBLICHE IN POSTEGGI DI MERCATO (INIZIO ATTIVITA') (AREA P. M.)	_____	PAG. 72
• MEDIA STRUTTURA DI VENDITA (APERTURA – TRASFERIMENTO) (AREA P. M.)	_____	PAG. 73
• SCIA ESERCIZIO SOMMINISTRAZIONE (AREA P. M.)	_____	PAG. 74
• AUTORIZZAZIONE APERTURA SALA GIOCHI (AREA P. M.)	_____	PAG. 75
• ORDINANZE INGIUNZIONE SANZIONI AI SENSI DELLA LEGGE 689/81 (AREA P. M.)	_____	PAG. 76
• VIDIMAZIONE DEI REGISTRI (AREA P. M.)	_____	PAG. 77
• AGIBILITA' LOCALI DI PUBBLICO SPETTACOLO E IMPIANTI SPORTIVI (AREA P. M.)	_____	PAG. 78
• SPETTACOLI VIAGGIANTI LUNA PARK (AREA P. M.)	_____	PAG. 79
• SPETTACOLI VIAGGIANTI REGISTRAZIONE E RILASCIO CODICE IDENTIFICATIVO (AREA P. M.)	_____	PAG. 80
• PROCEDIMENTI LIMITATIVI DELLA SFERA GIURIDICA DELL'IMPRESA (AREA P. M.)	_____	PAG. 81
• ASSEGNAZIONE CASSONETTI RIFIUTI RACCOLTA DIFFERENZIATA PORTA A PORTA (AREA P. M.)	_____	PAG. 82
• GESTIONE SEGNALE RACCOLTA RIFIUTI (AREA P. M.)	_____	PAG. 83
• RILASCIO TESSERE UTILIZZO INTERRATI (AREA P. M.)	_____	PAG.84

# 1 DIAGRAMMA 1

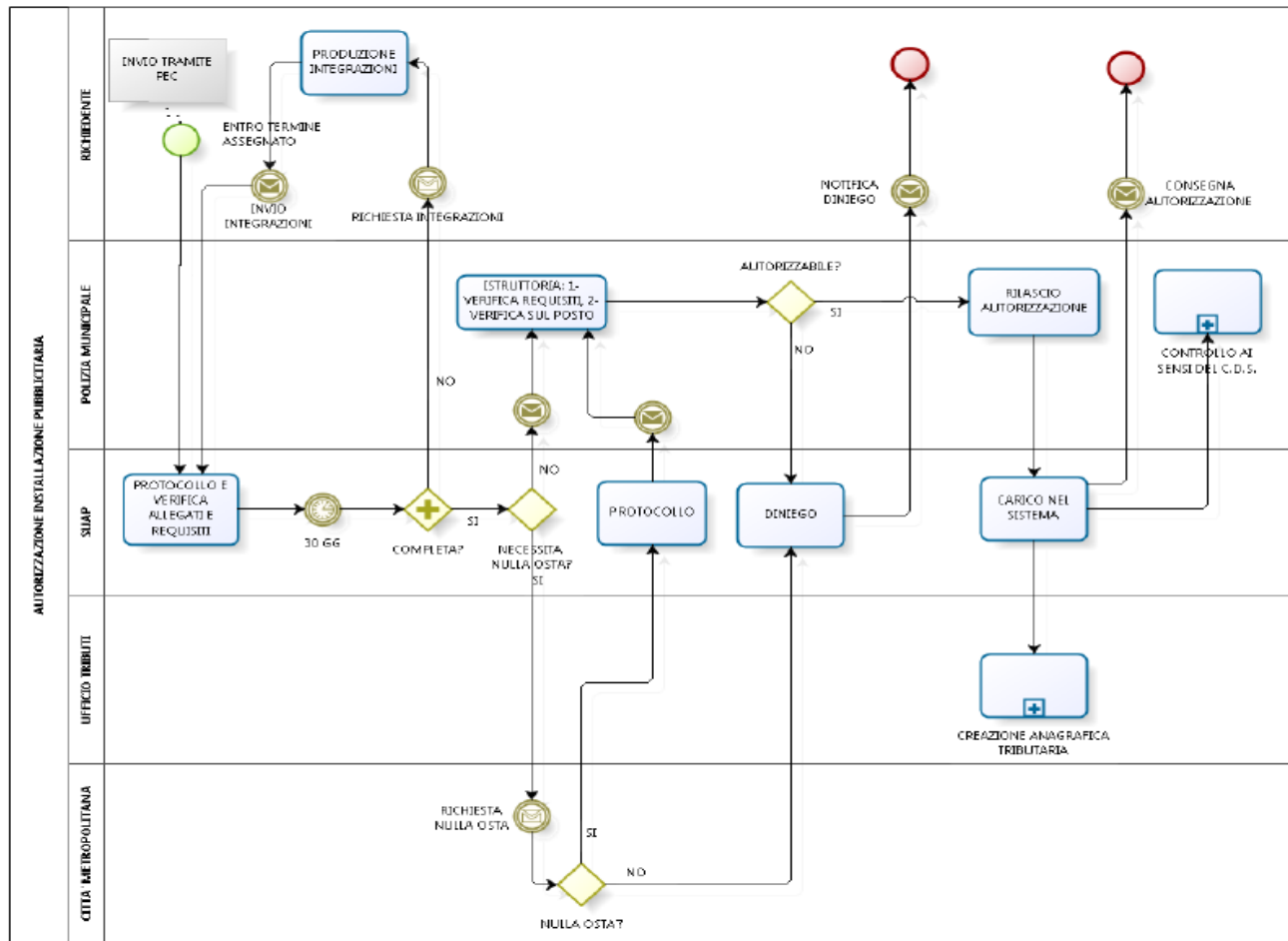

# 1 DIAGRAMMA 1

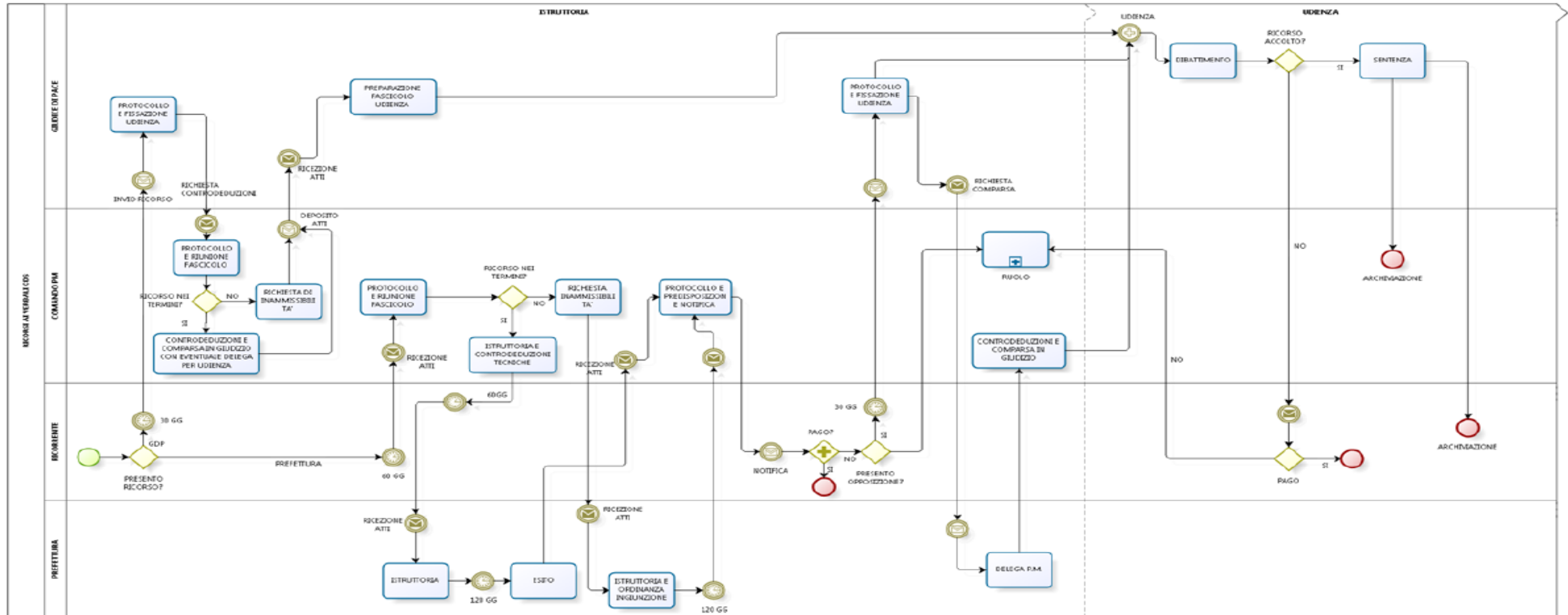

# 1 DIAGRAMMA 1

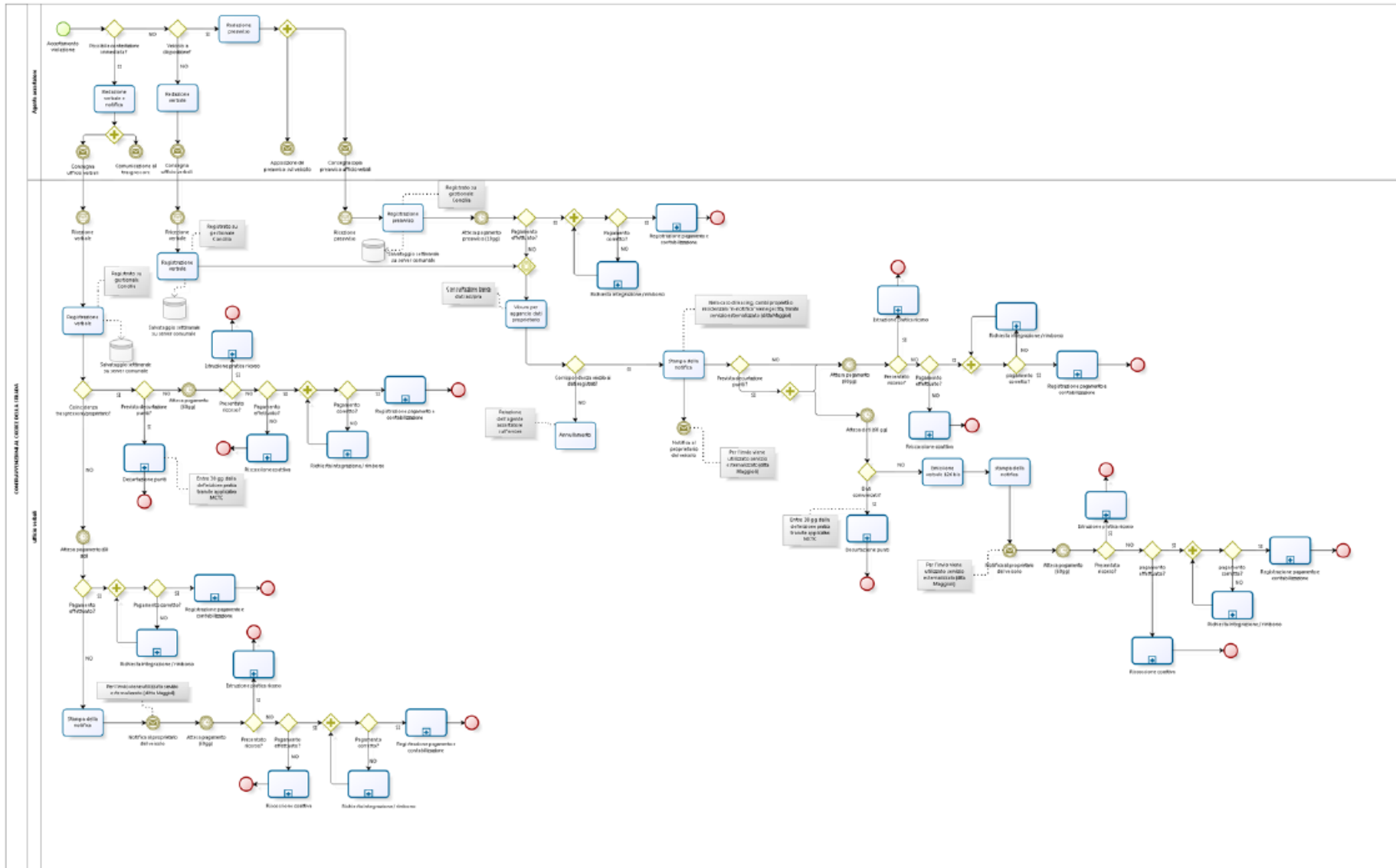

# 1 DIAGRAMMA 1

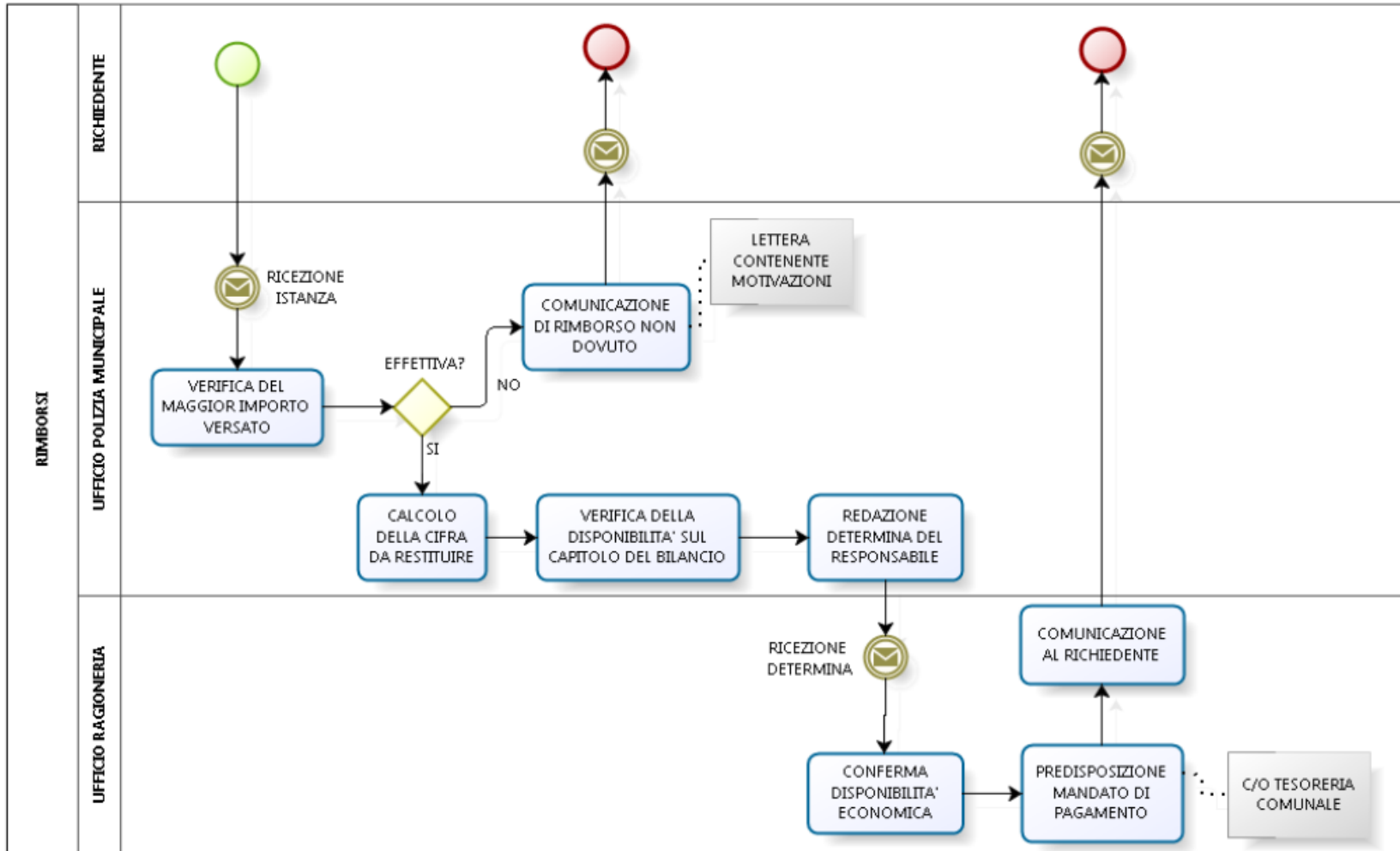

# 1 DIAGRAMMA 1

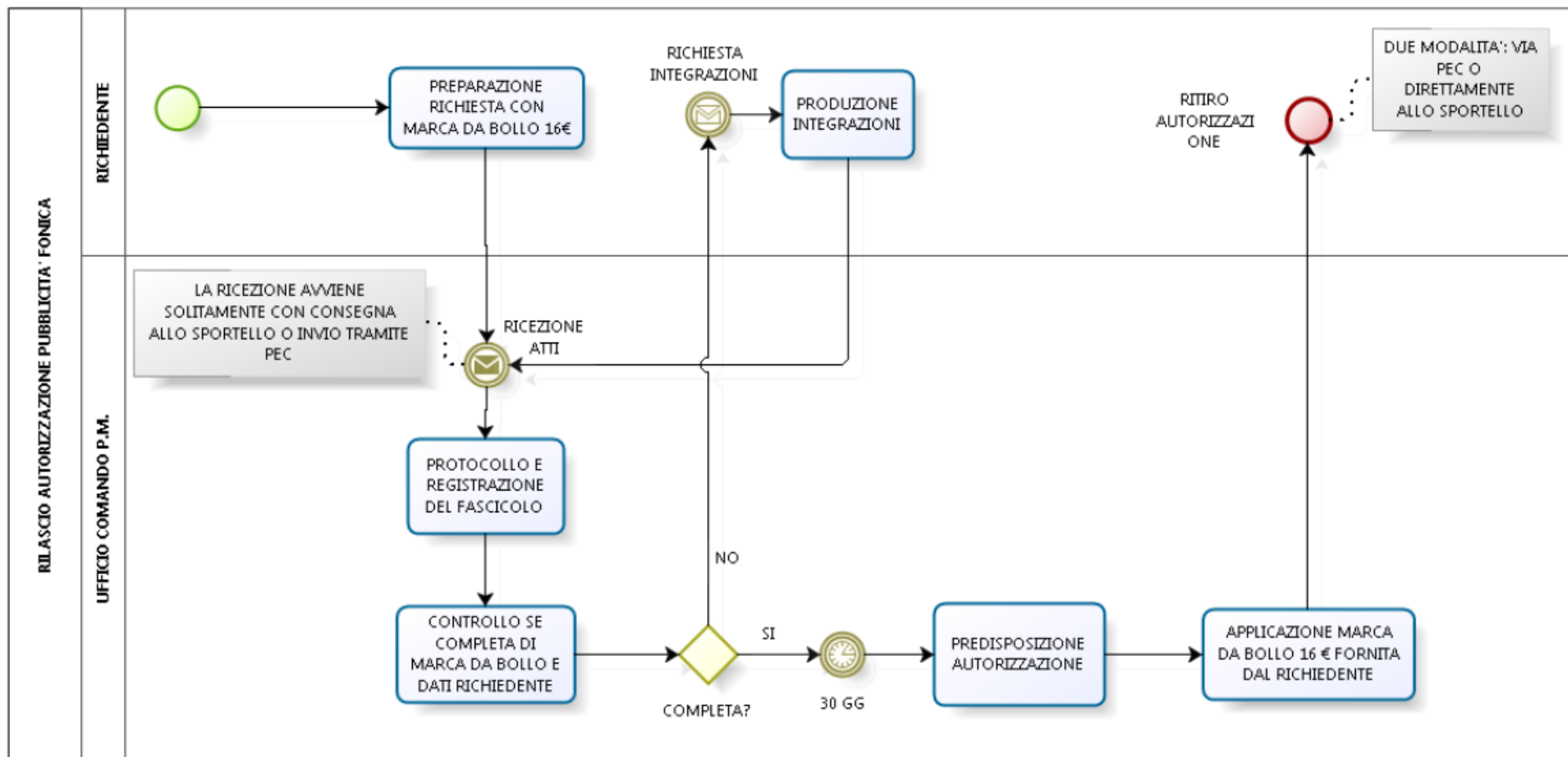

# 1 DIAGRAMMA 1

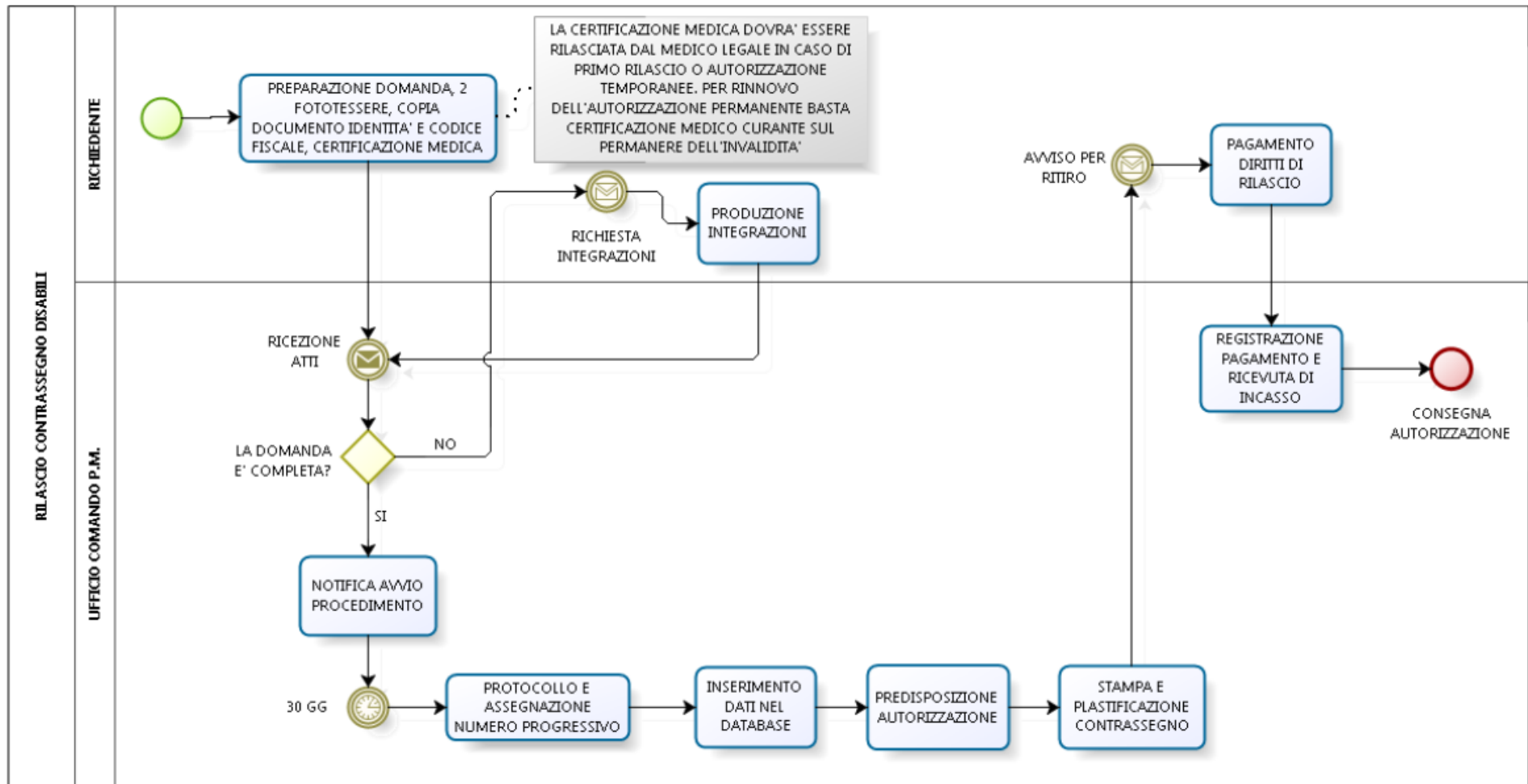



# 1 DIAGRAMMA 1

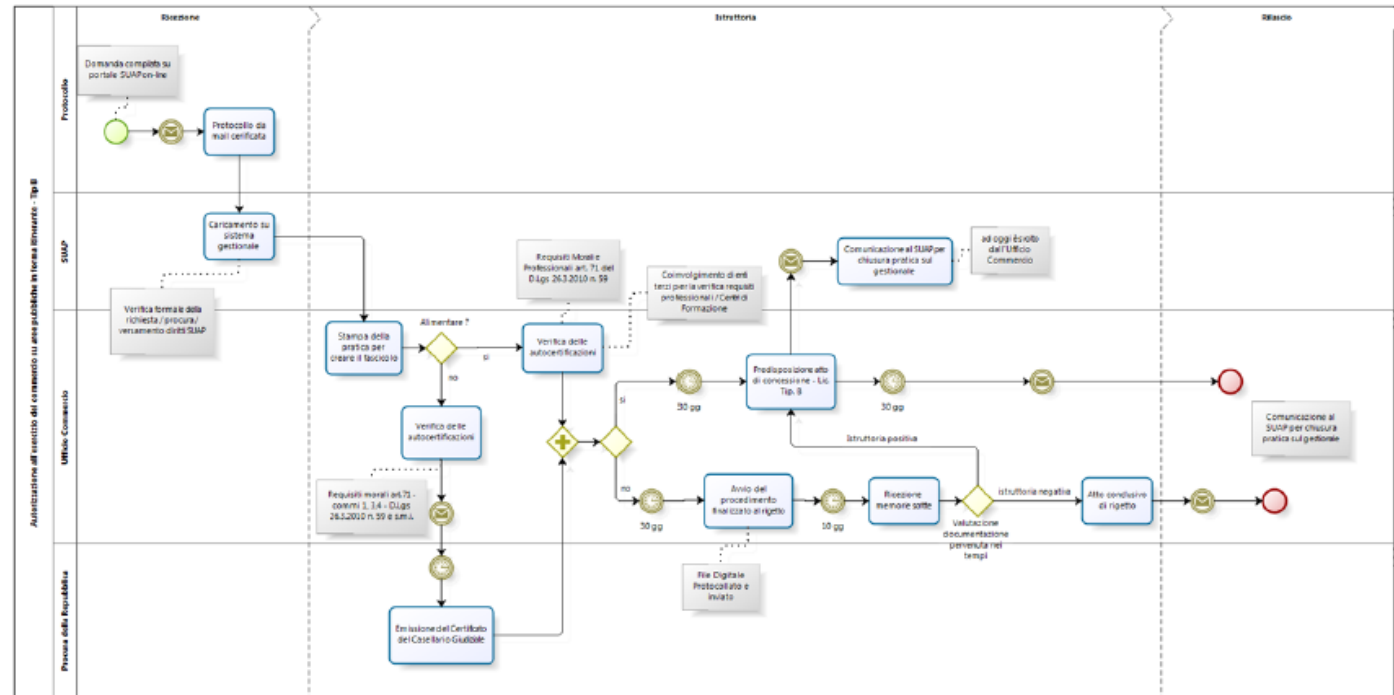

# 1 DIAGRAMMA 1

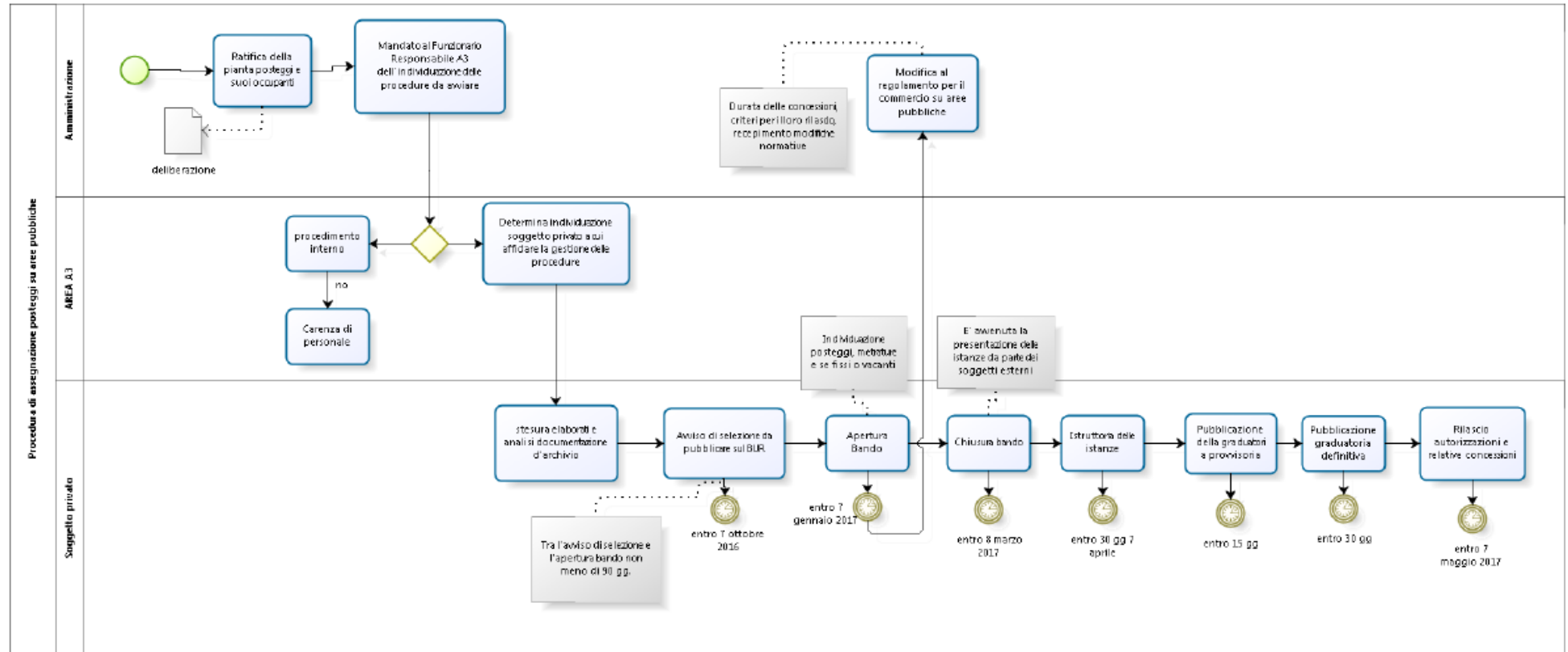

# 1 DIAGRAMMA 1

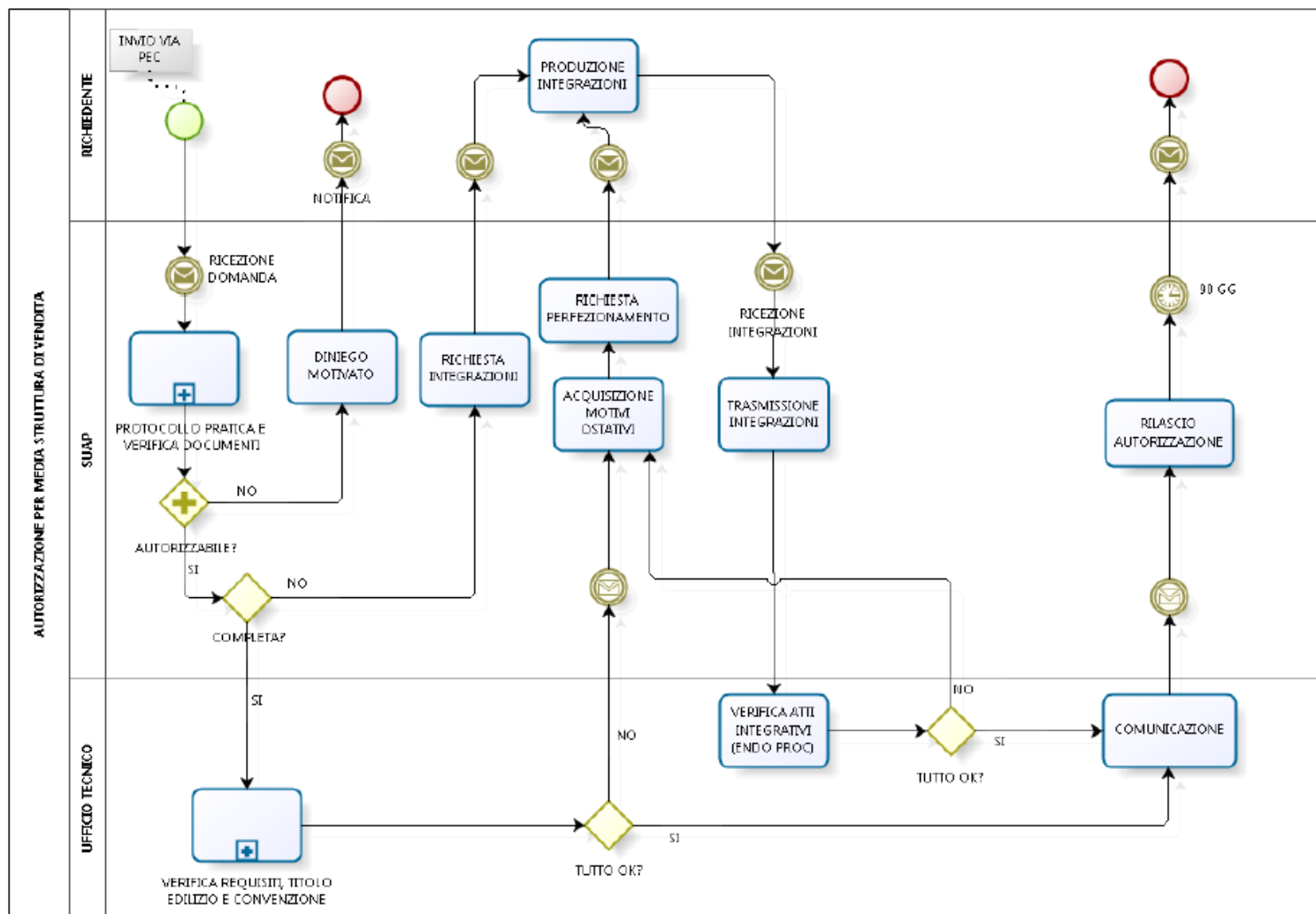

# 1 DIAGRAMMA 1

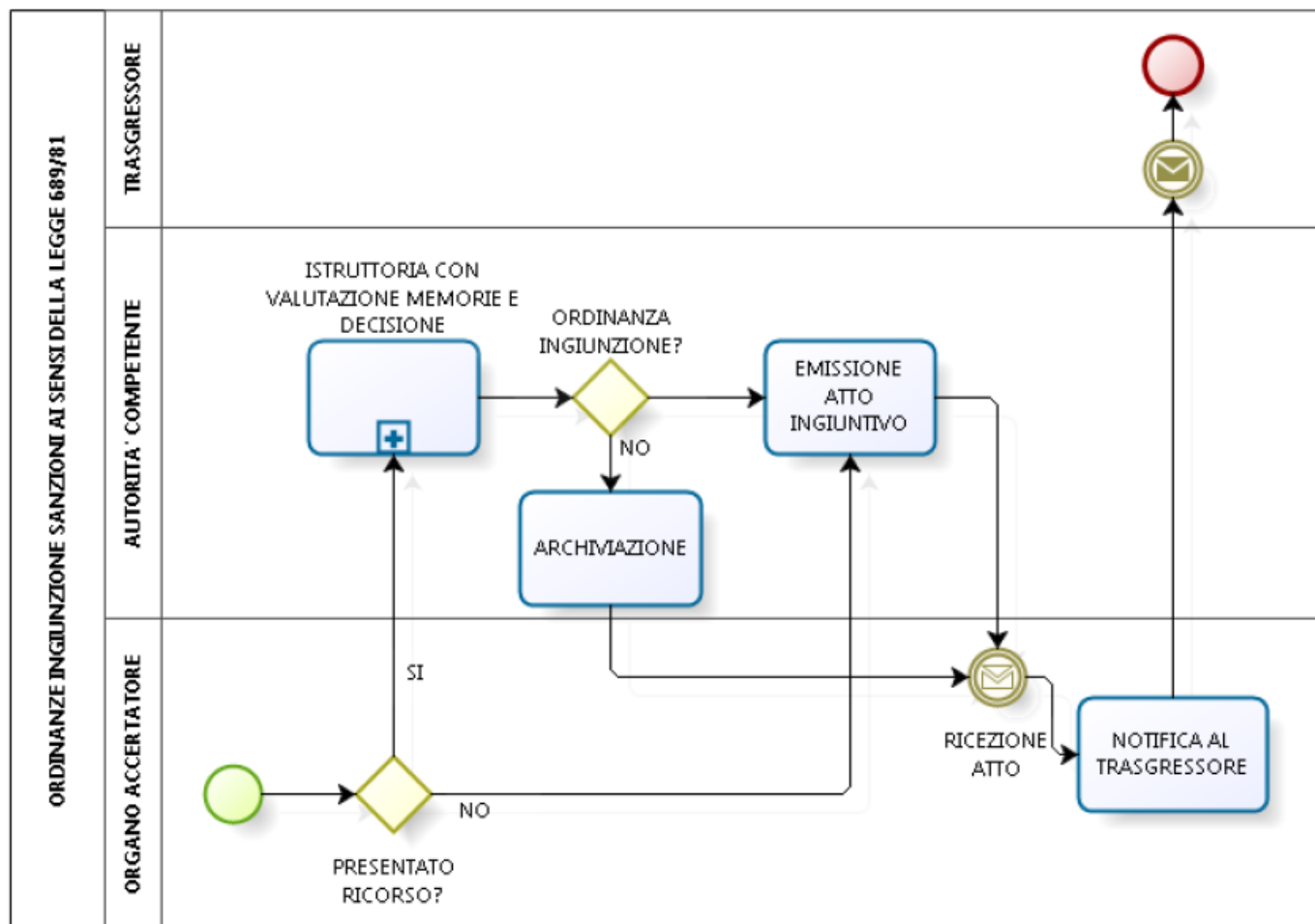

# 1 DIAGRAMMA 1

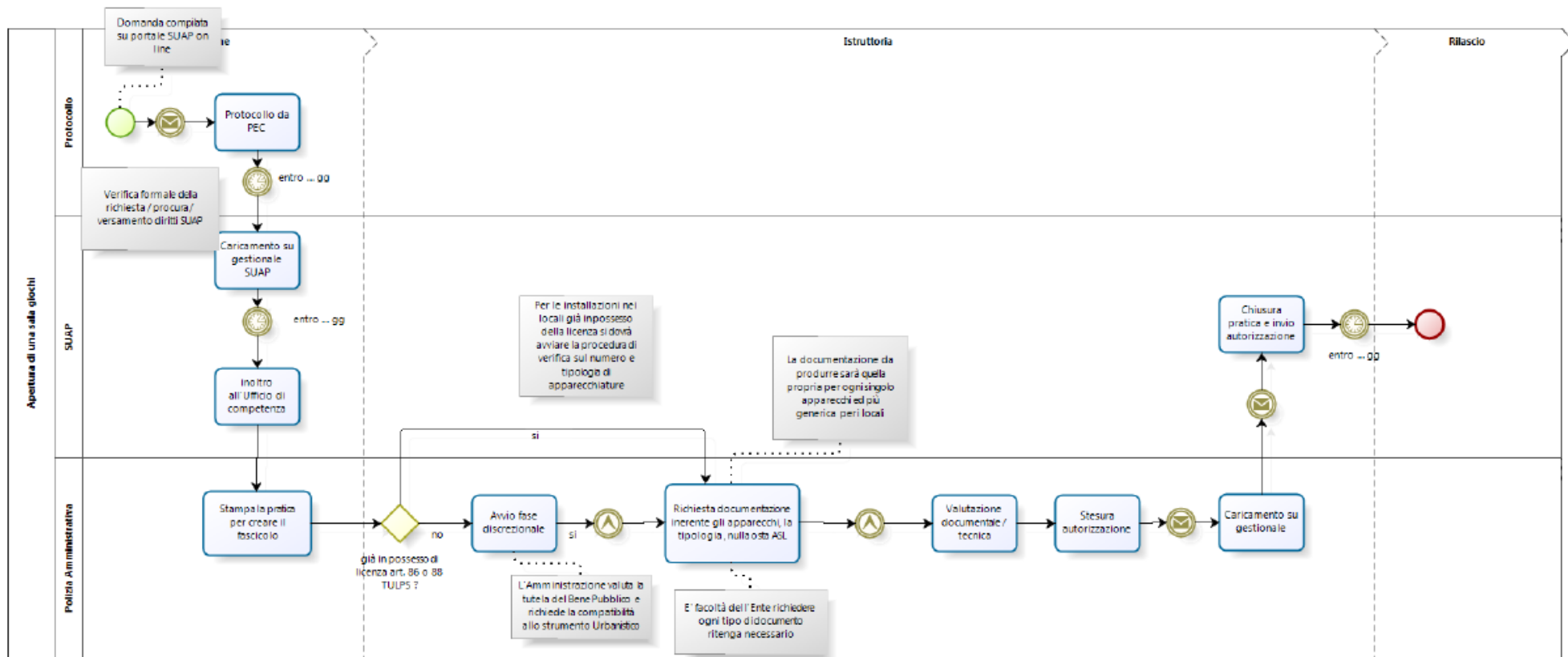

# 1 DIAGRAMMA 1

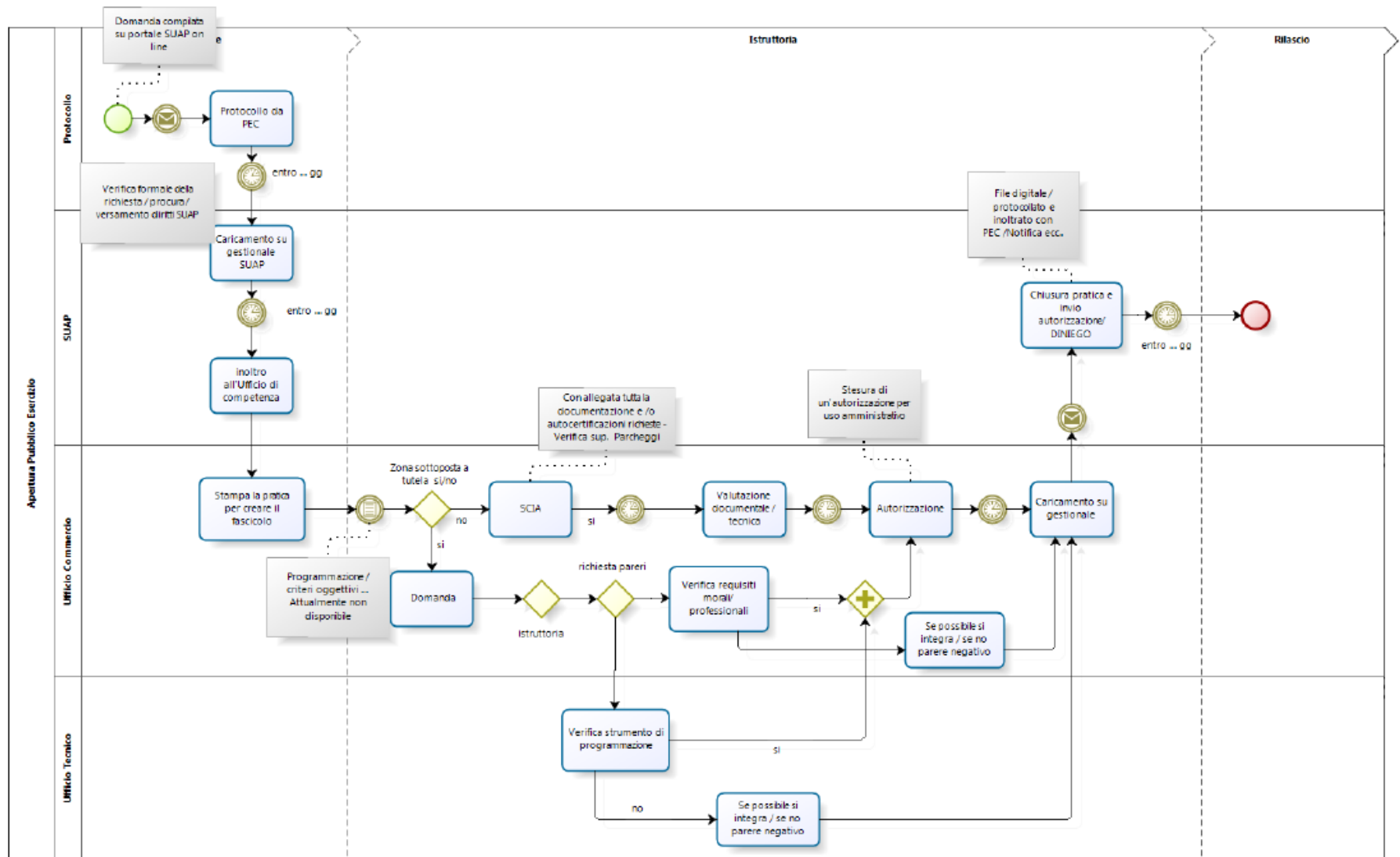

# 1 DIAGRAMMA 1

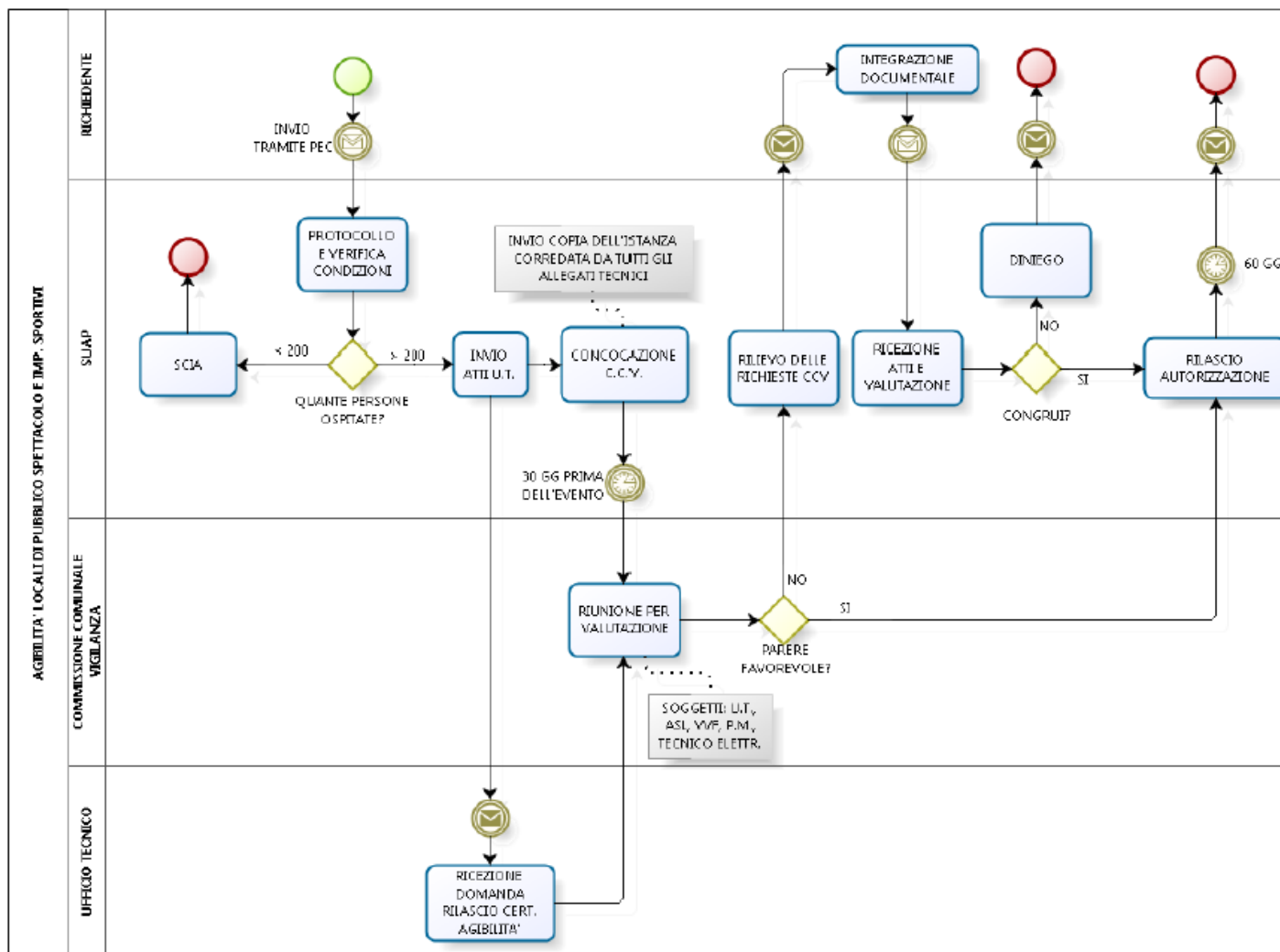

# 1 DIAGRAMMA 1

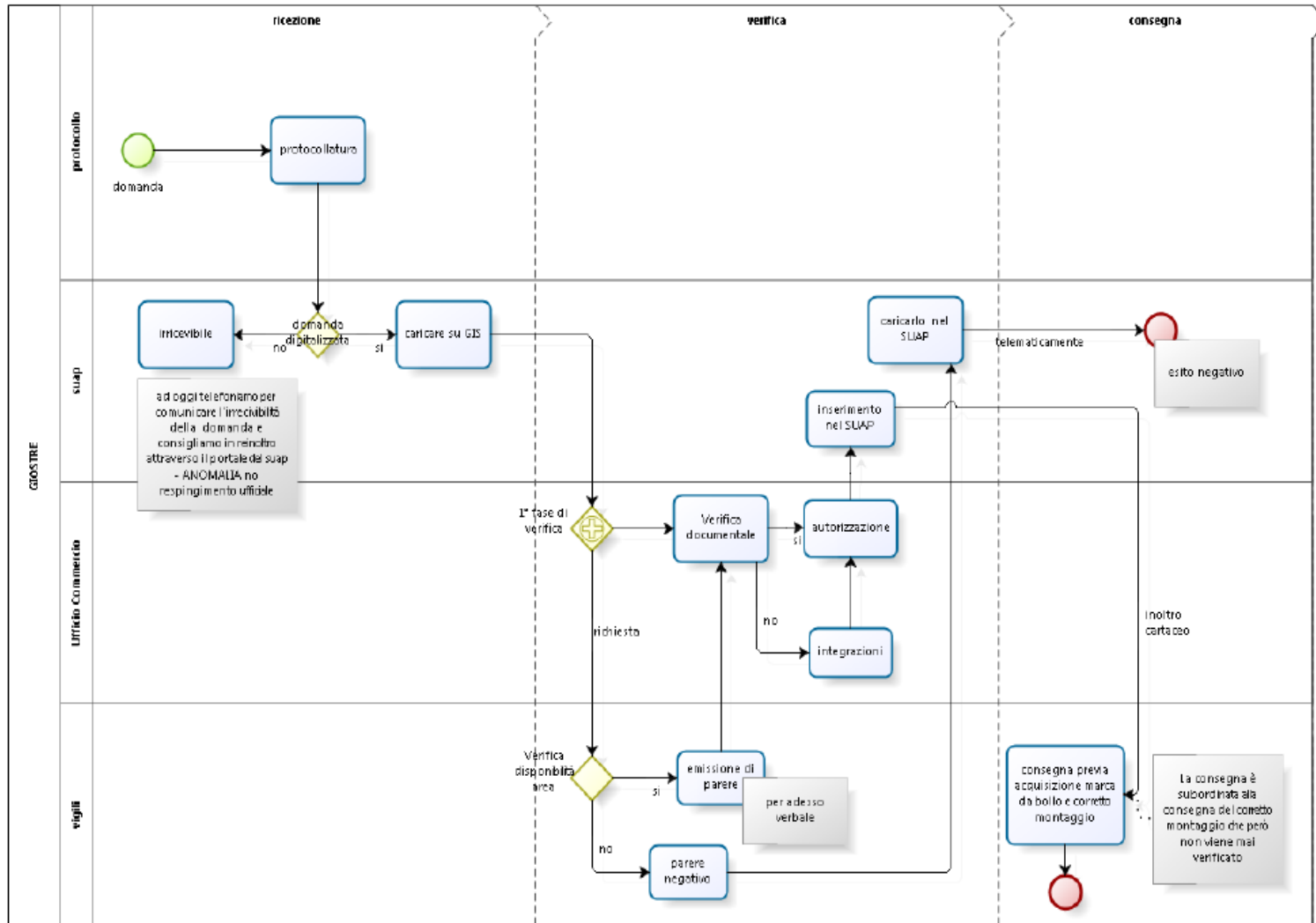



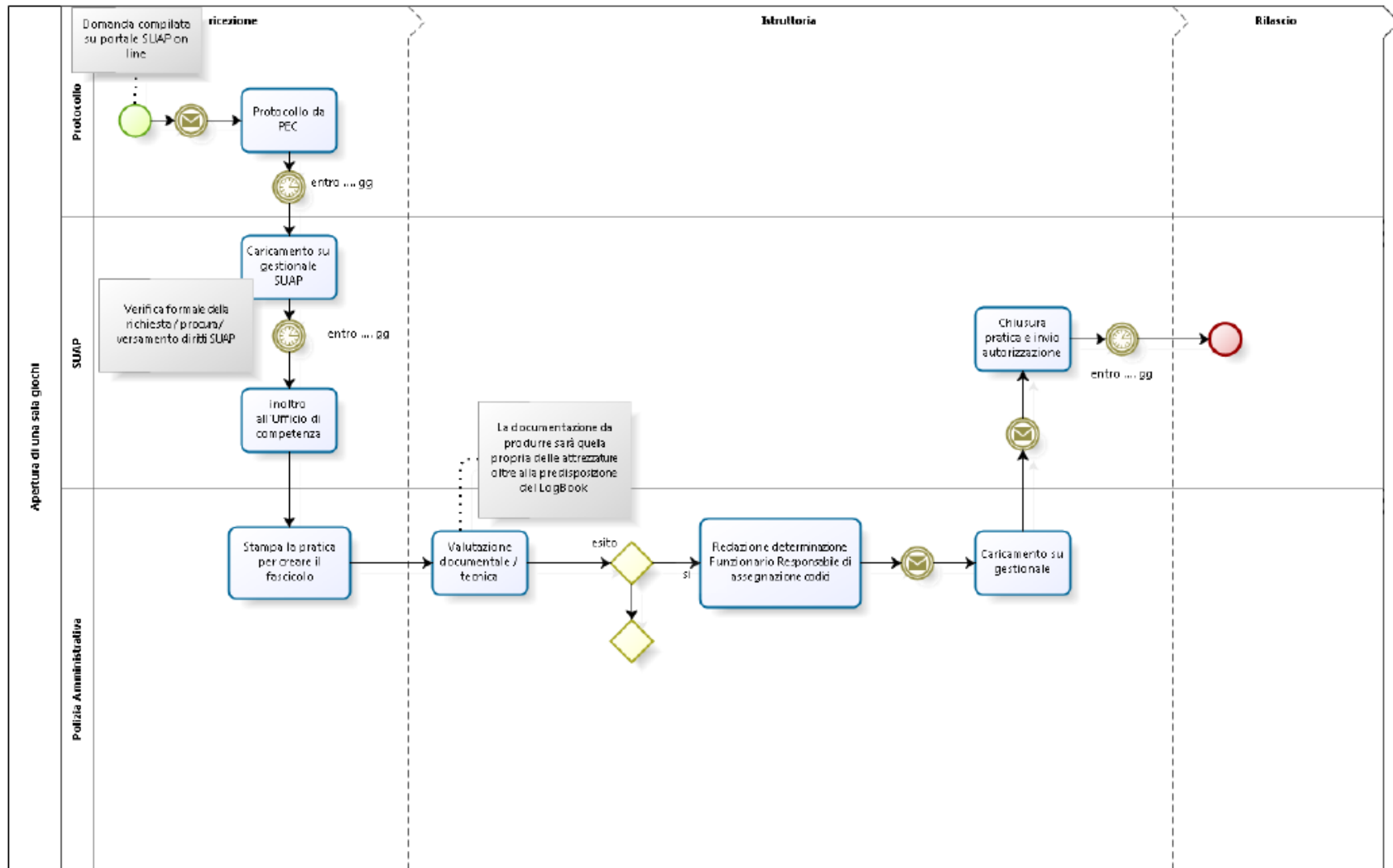

# 1 DIAGRAMMA 1

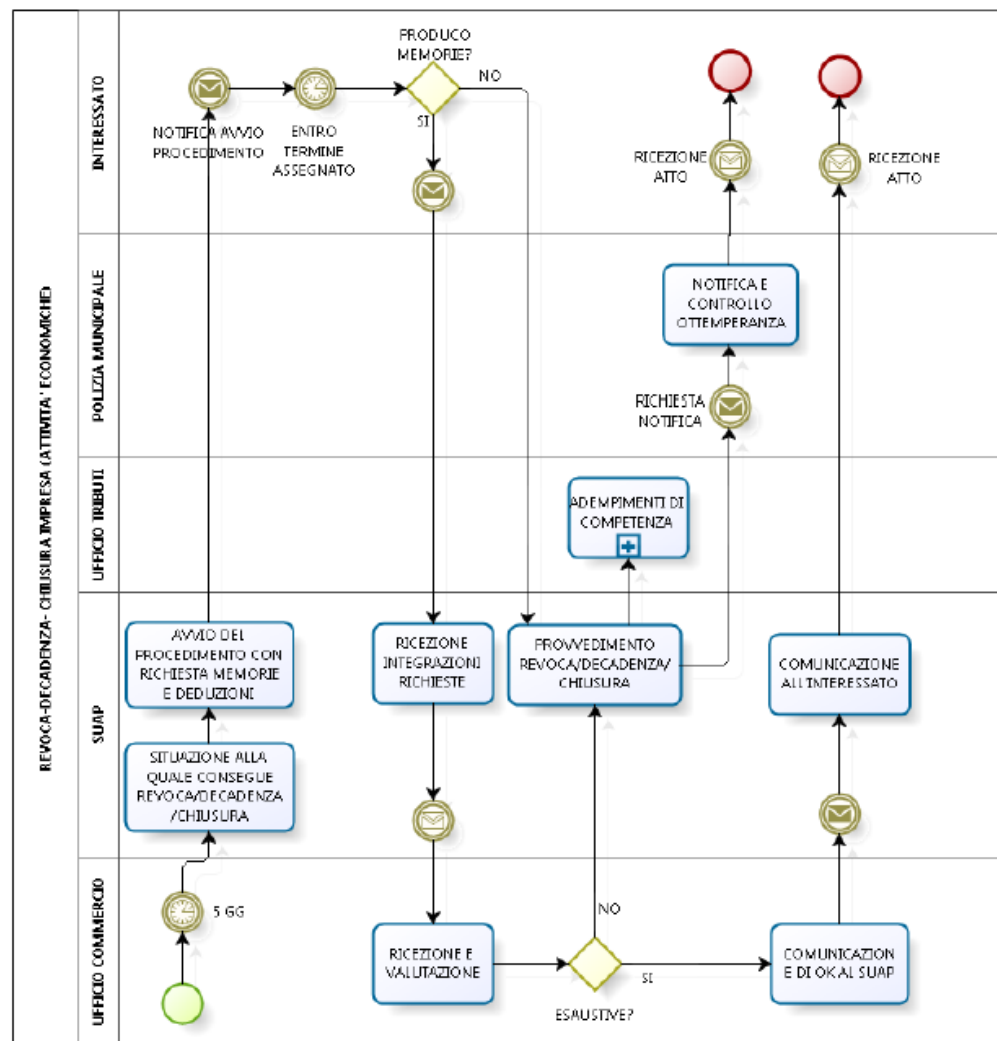

# 1 GESTIONE CASSA ECONOMALE E PICCOLE SPESE

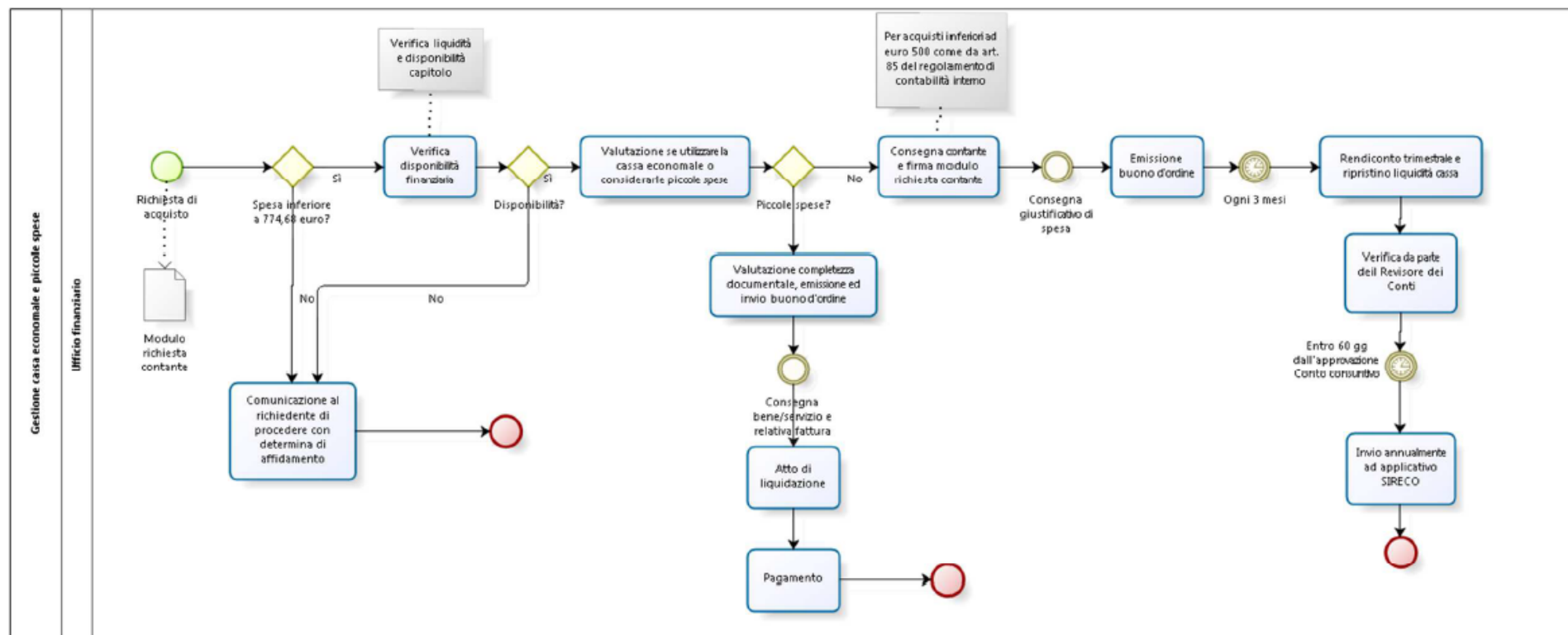

# 1 DIAGRAMMA 1

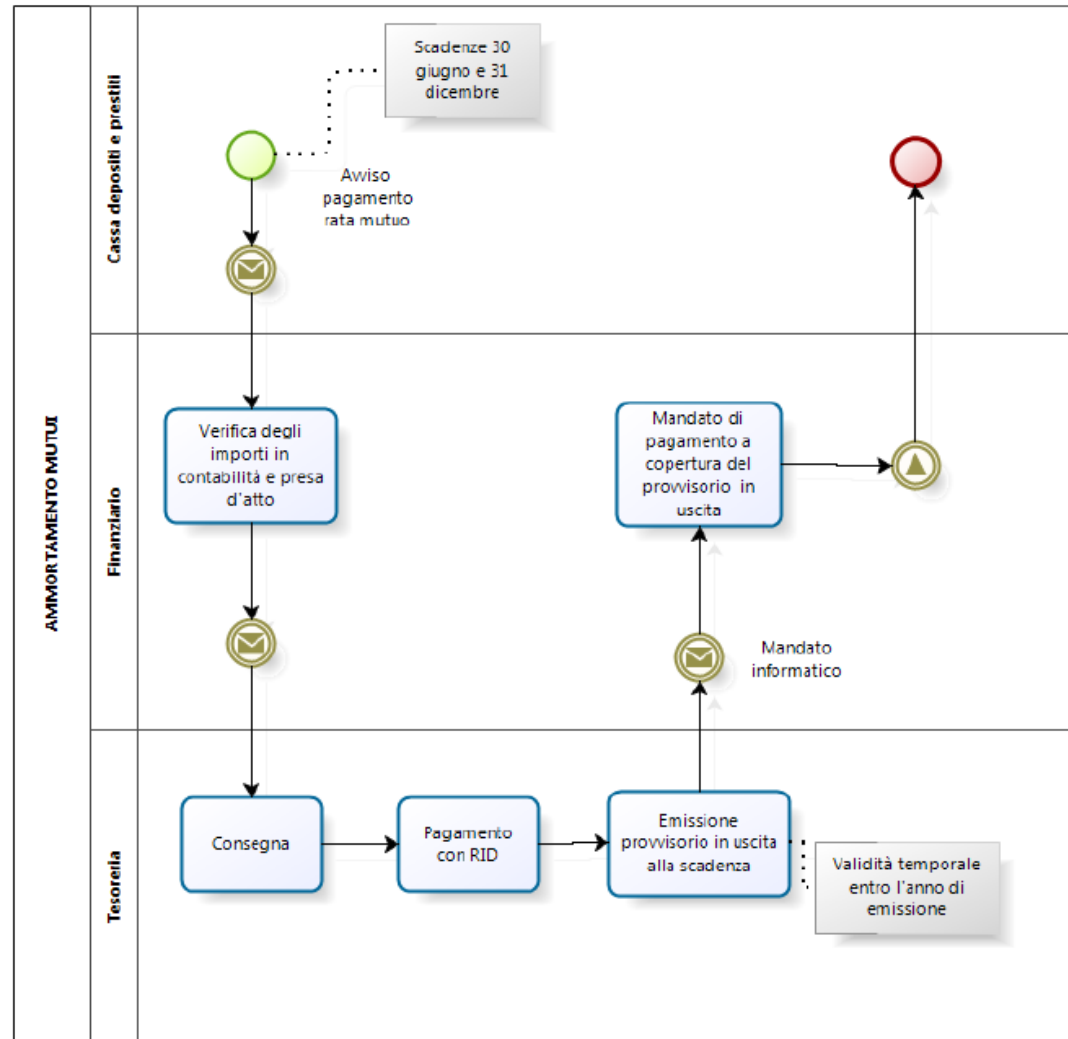

# 1 DIAGRAMMA 1

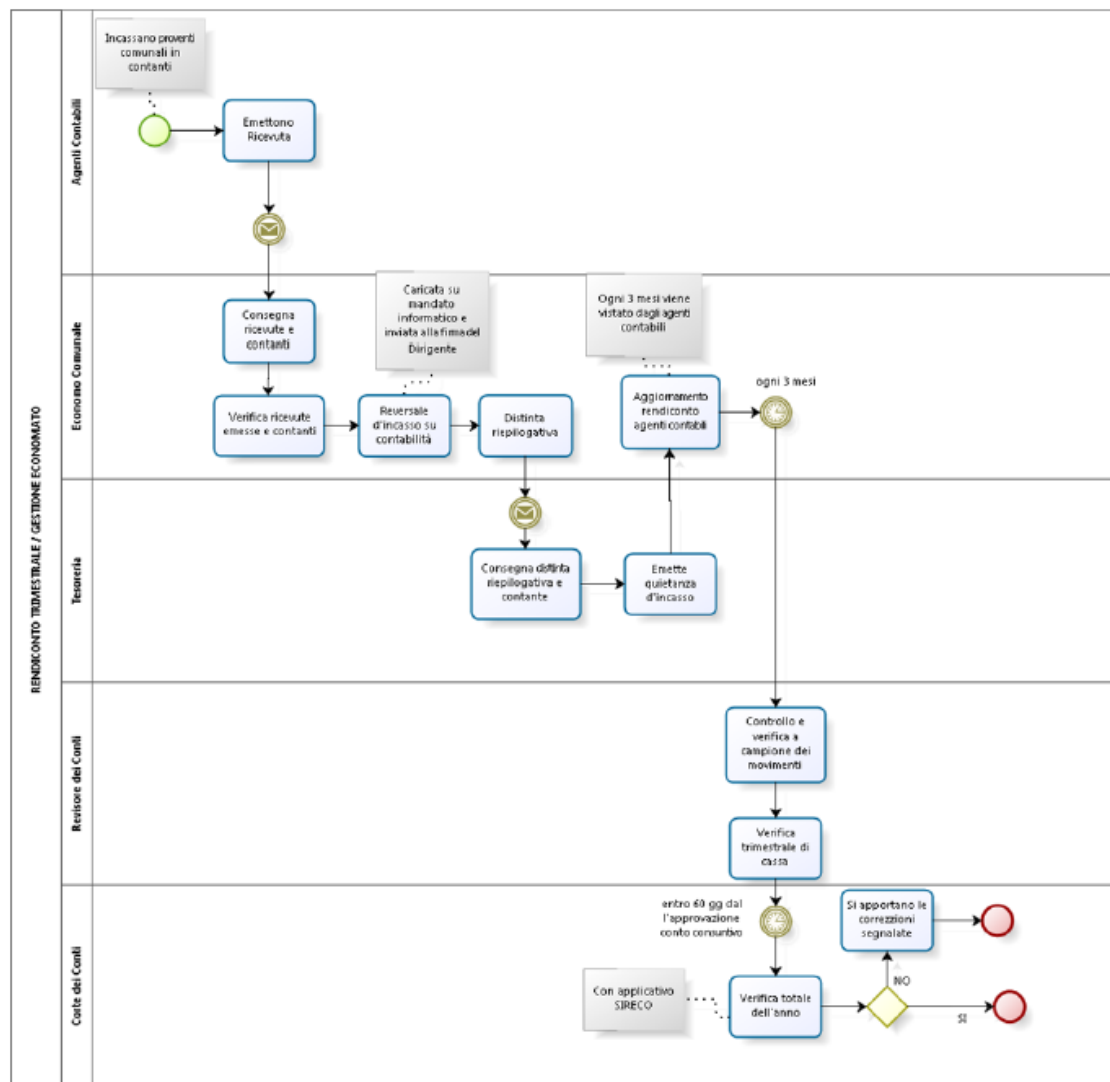

# 1 DIAGRAMMA 1

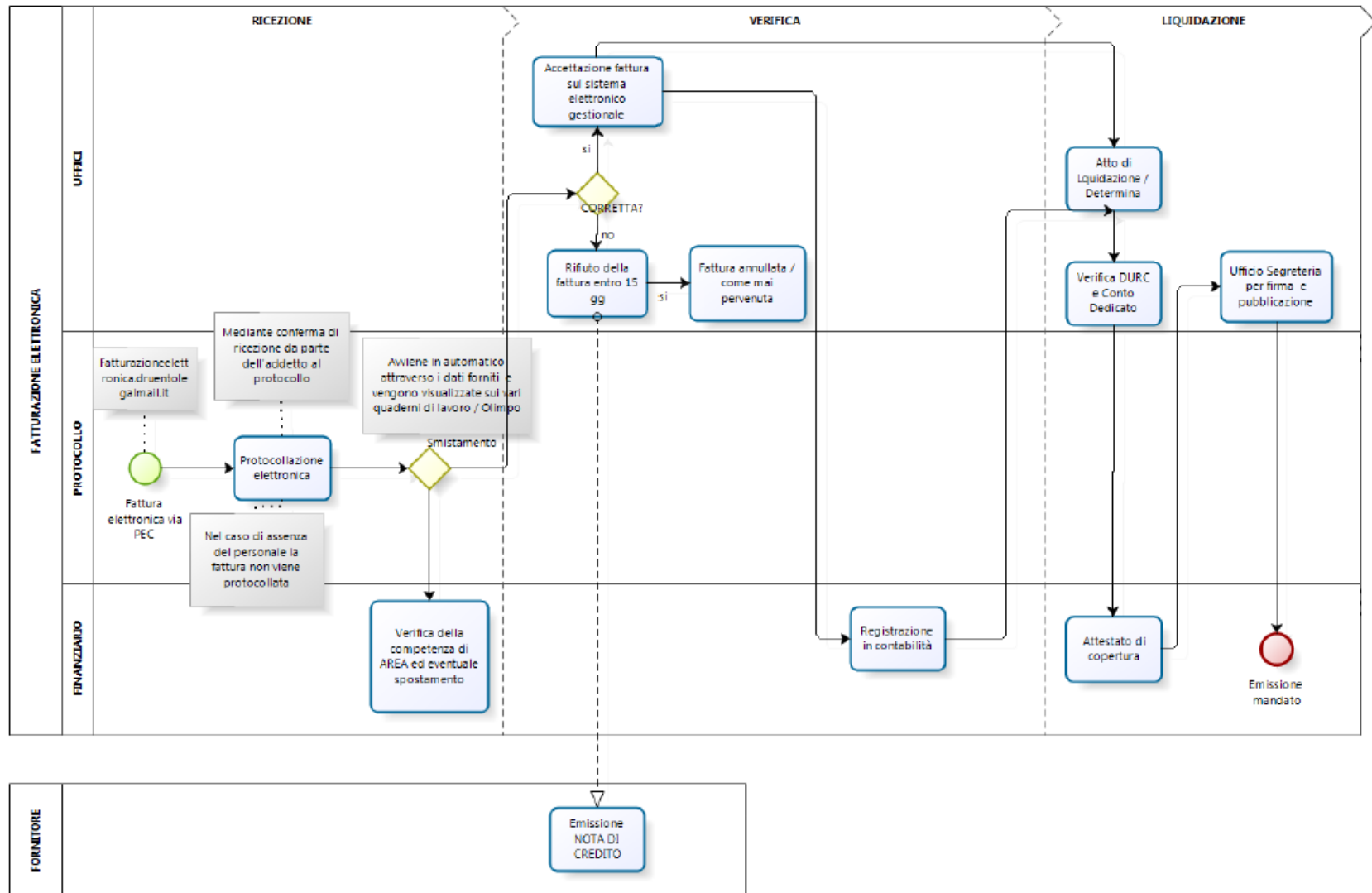

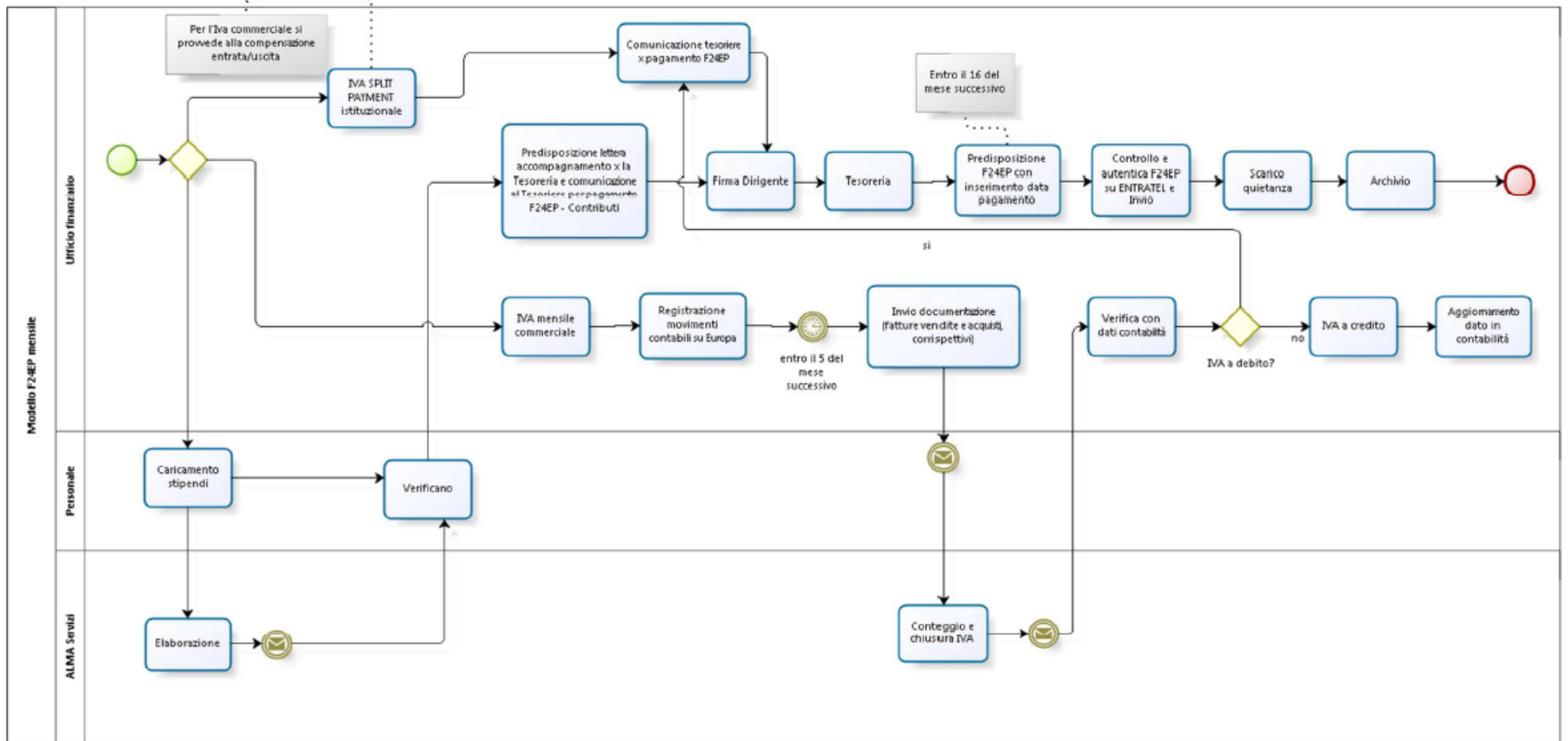

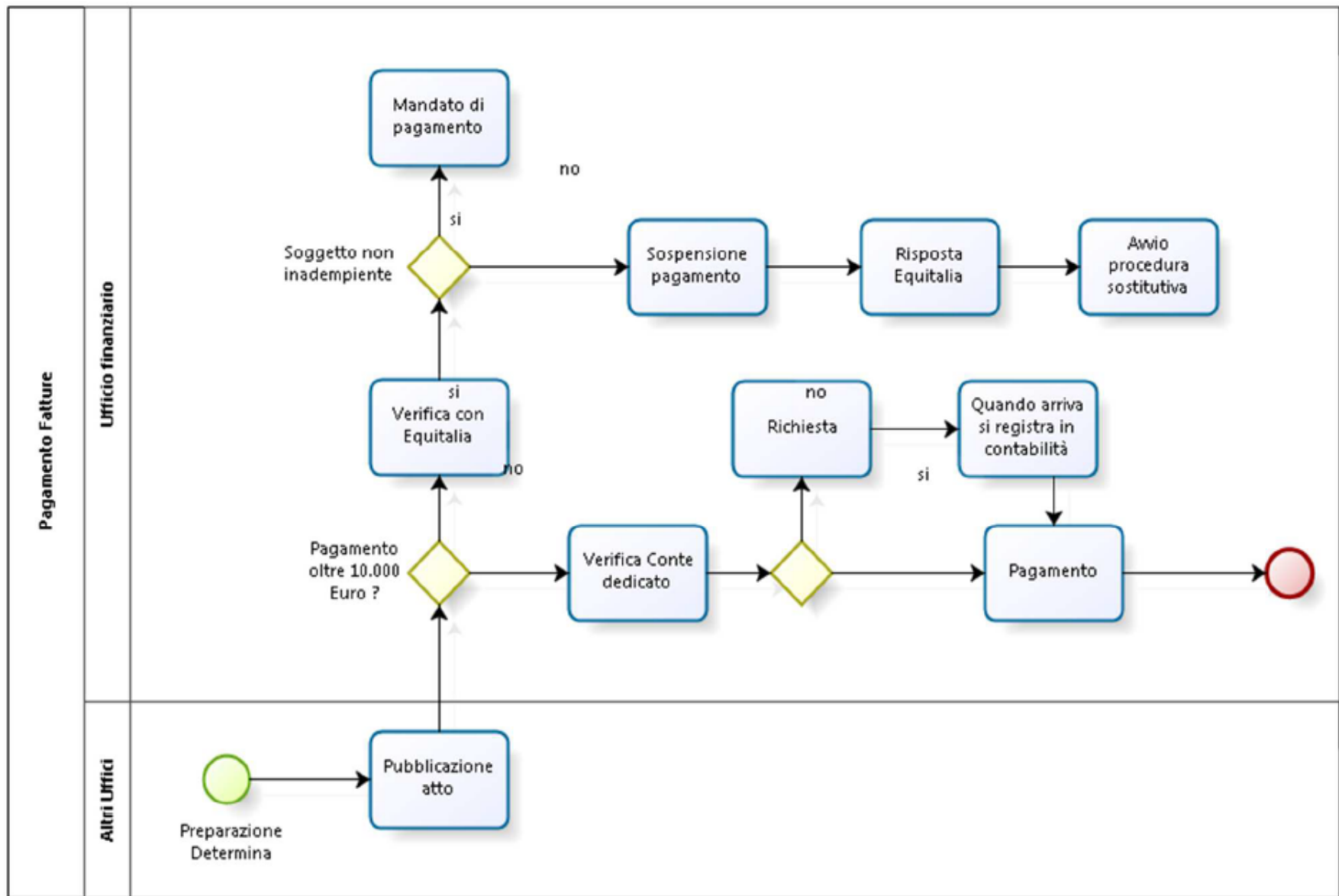



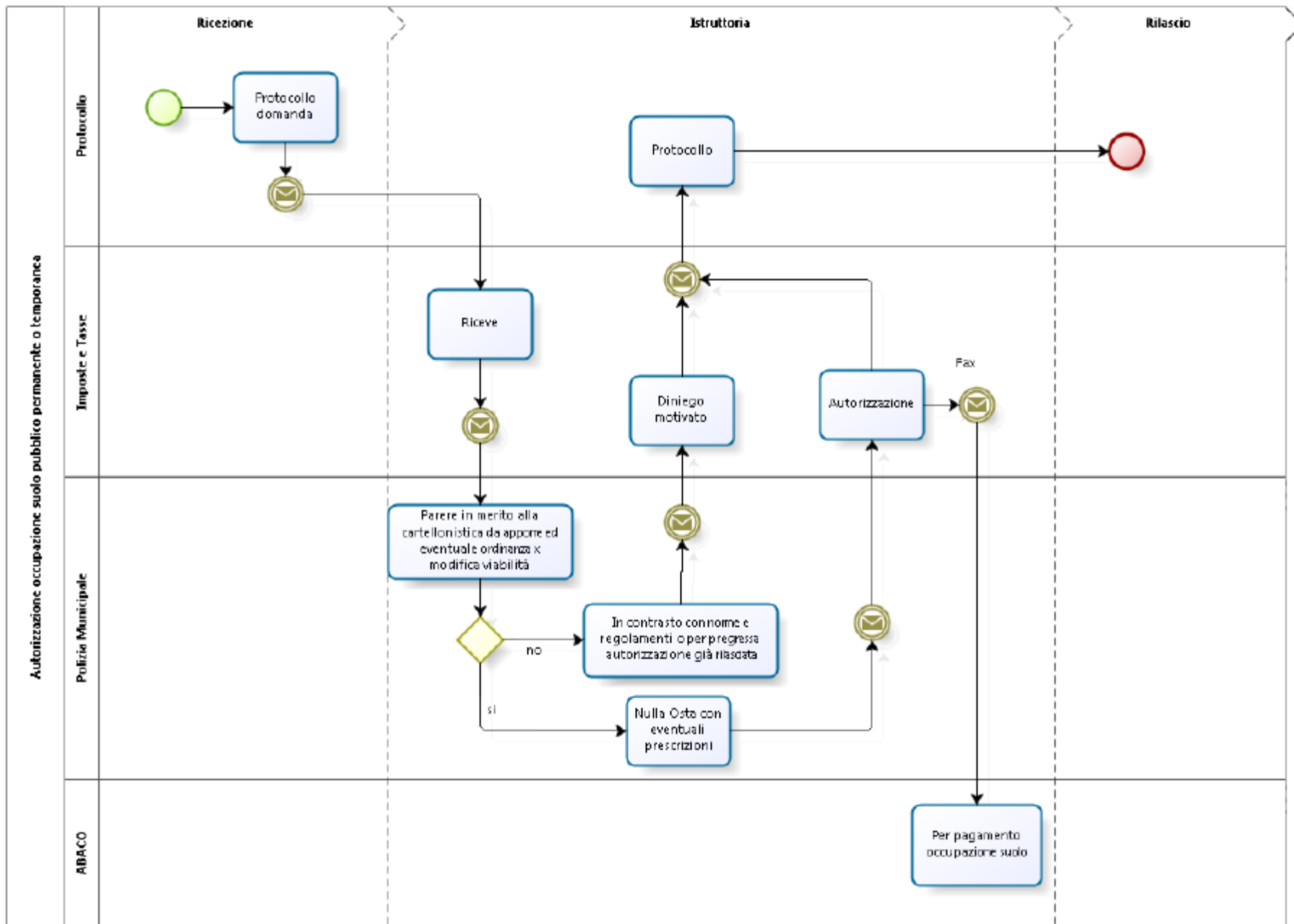

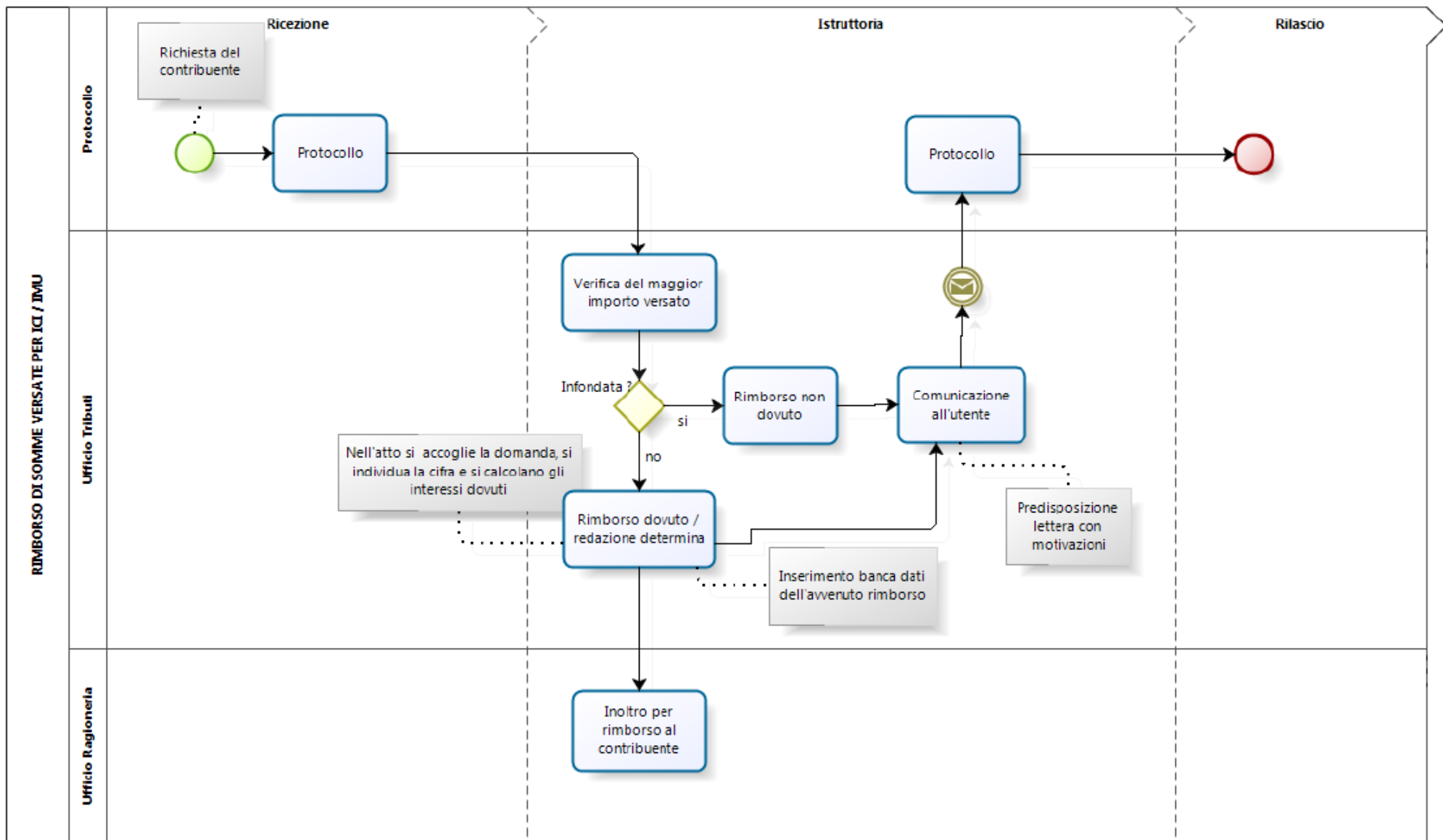

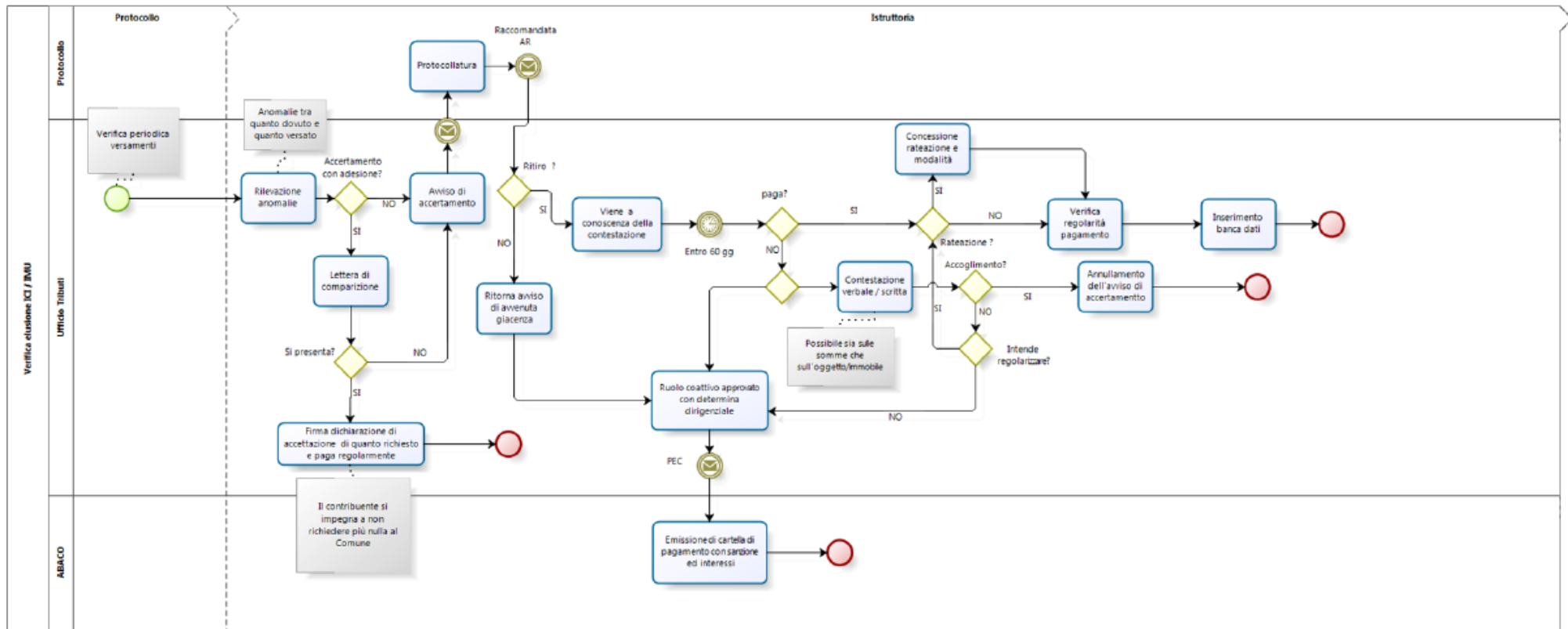

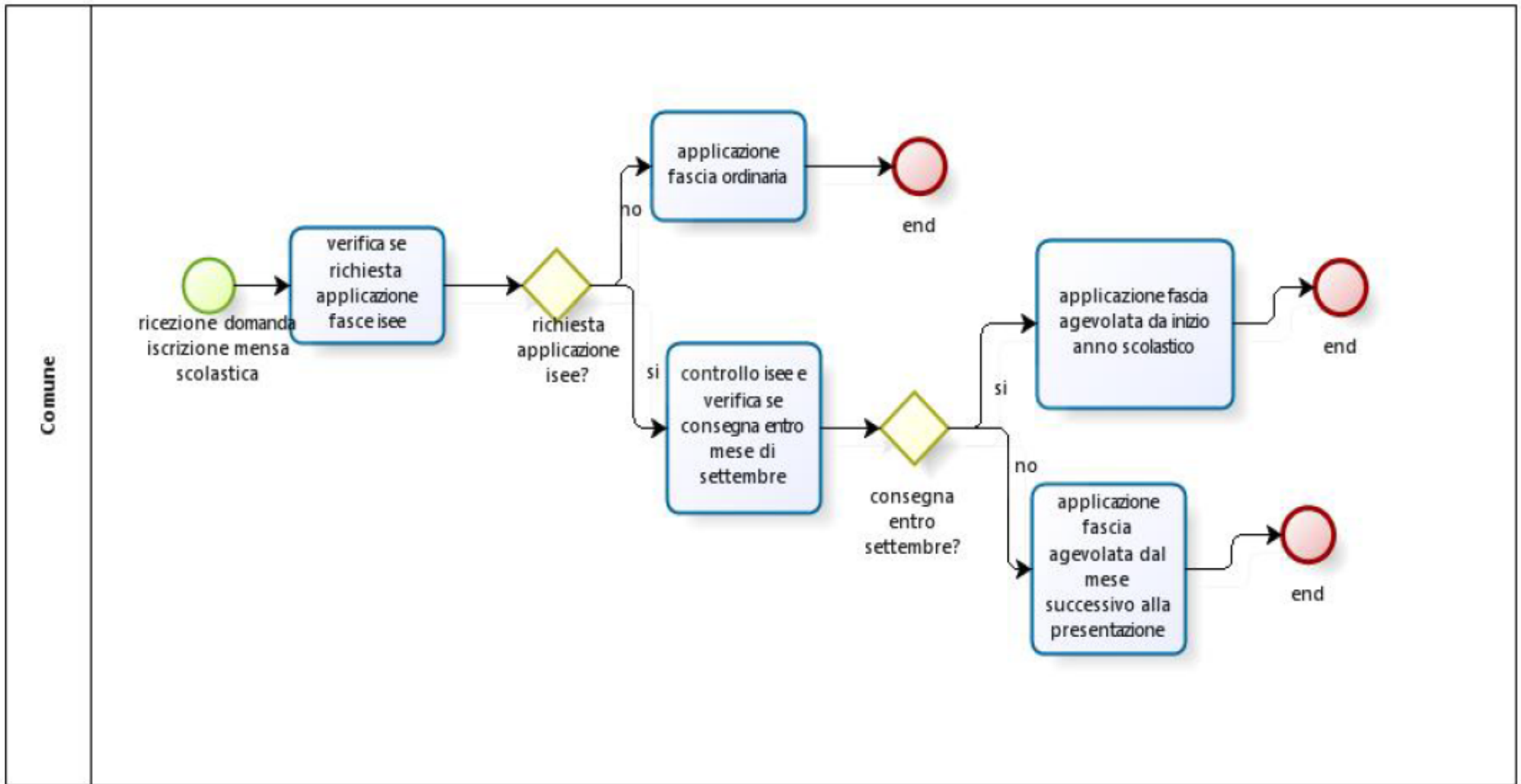

APPLICAZIONE AGEVOLAZIONI ISEE PER MENSA SCOLASTICA

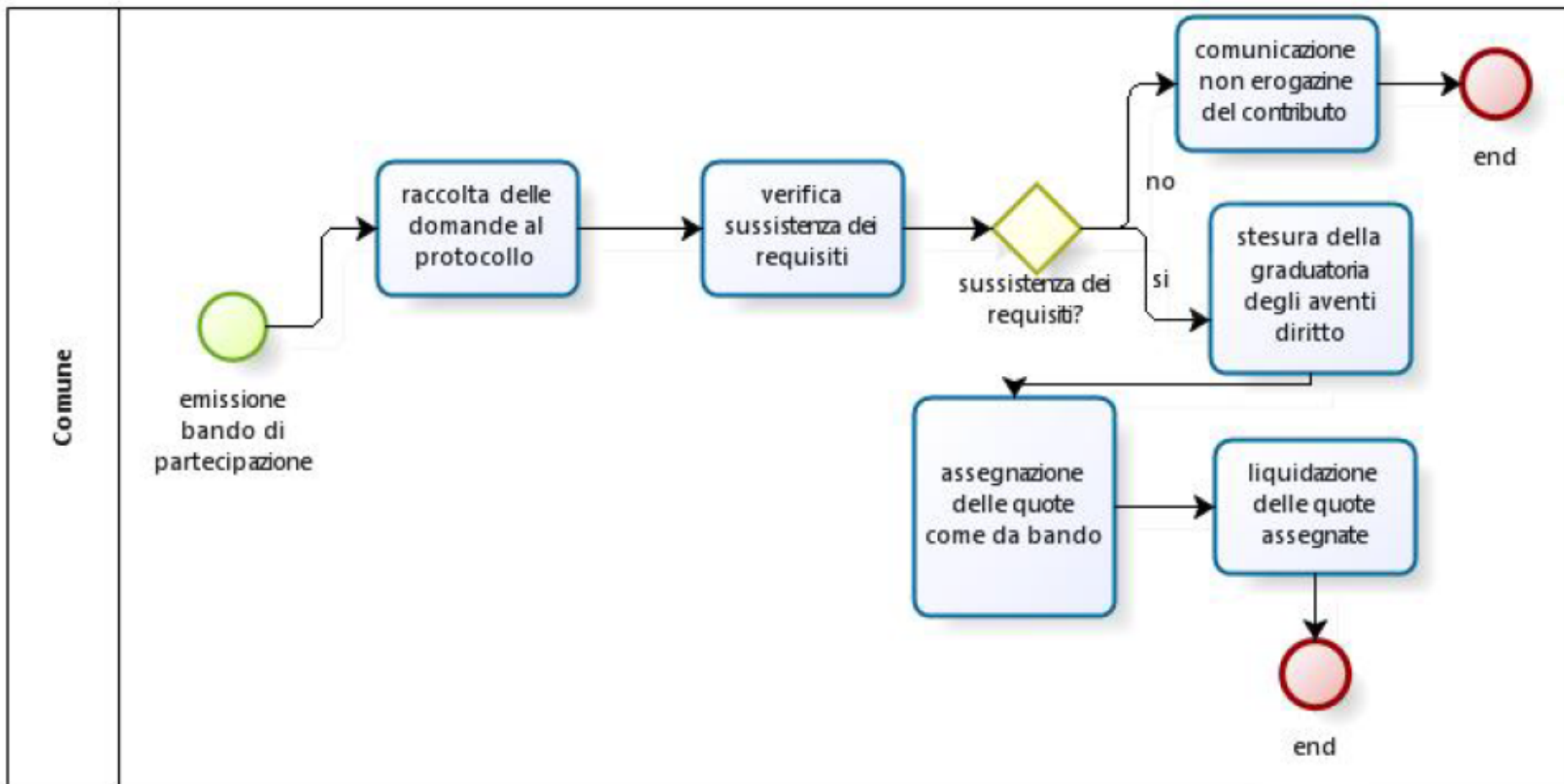

ASSEGNAZIONE CONTRIBUTO COMUNALE ALLE FAMIGLIE PER ASILO NIDO

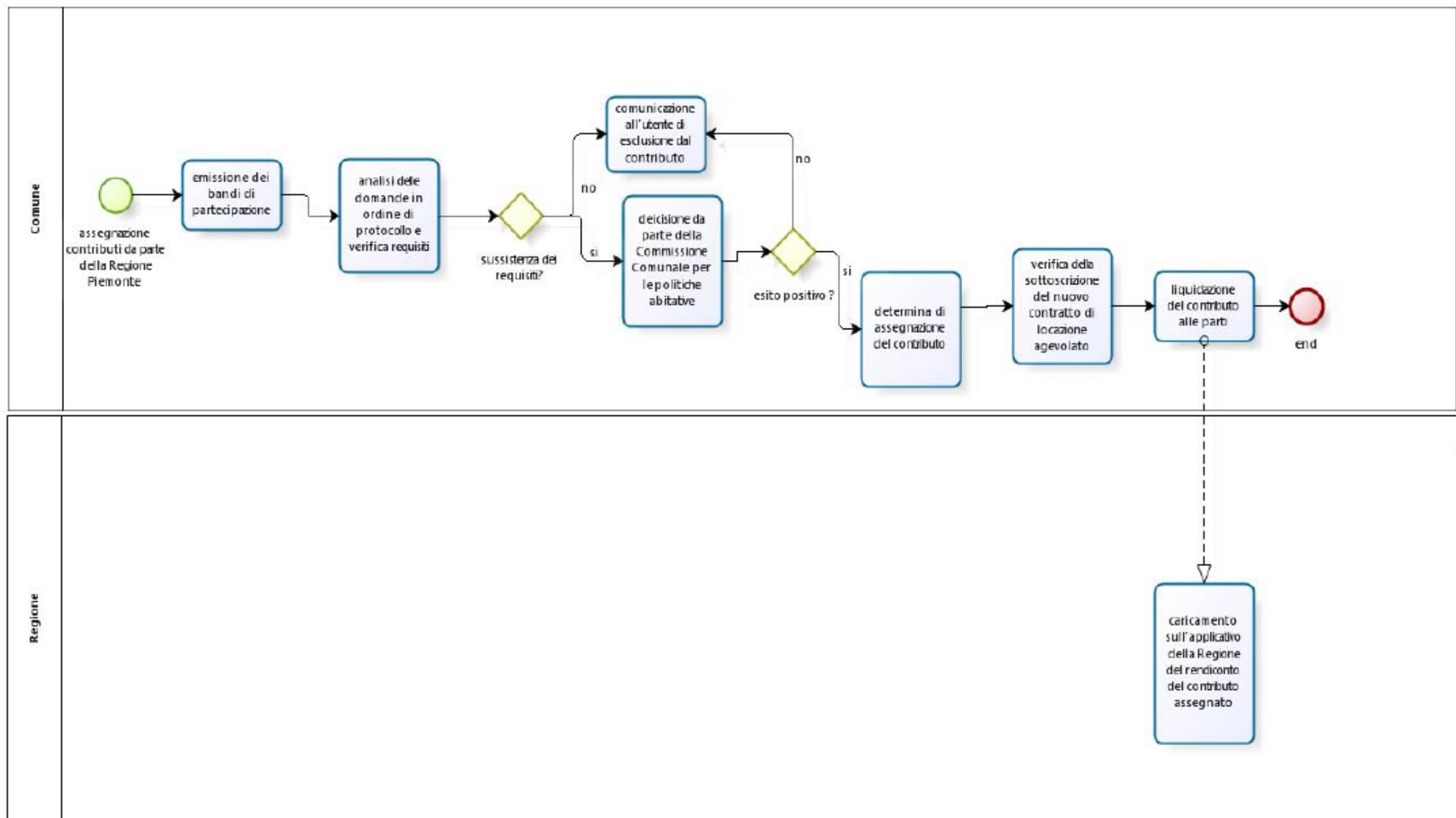

ASSEGNAZIONE ED EROGAZIONE FONDI FIMI E ASLO DELLA REGIONE

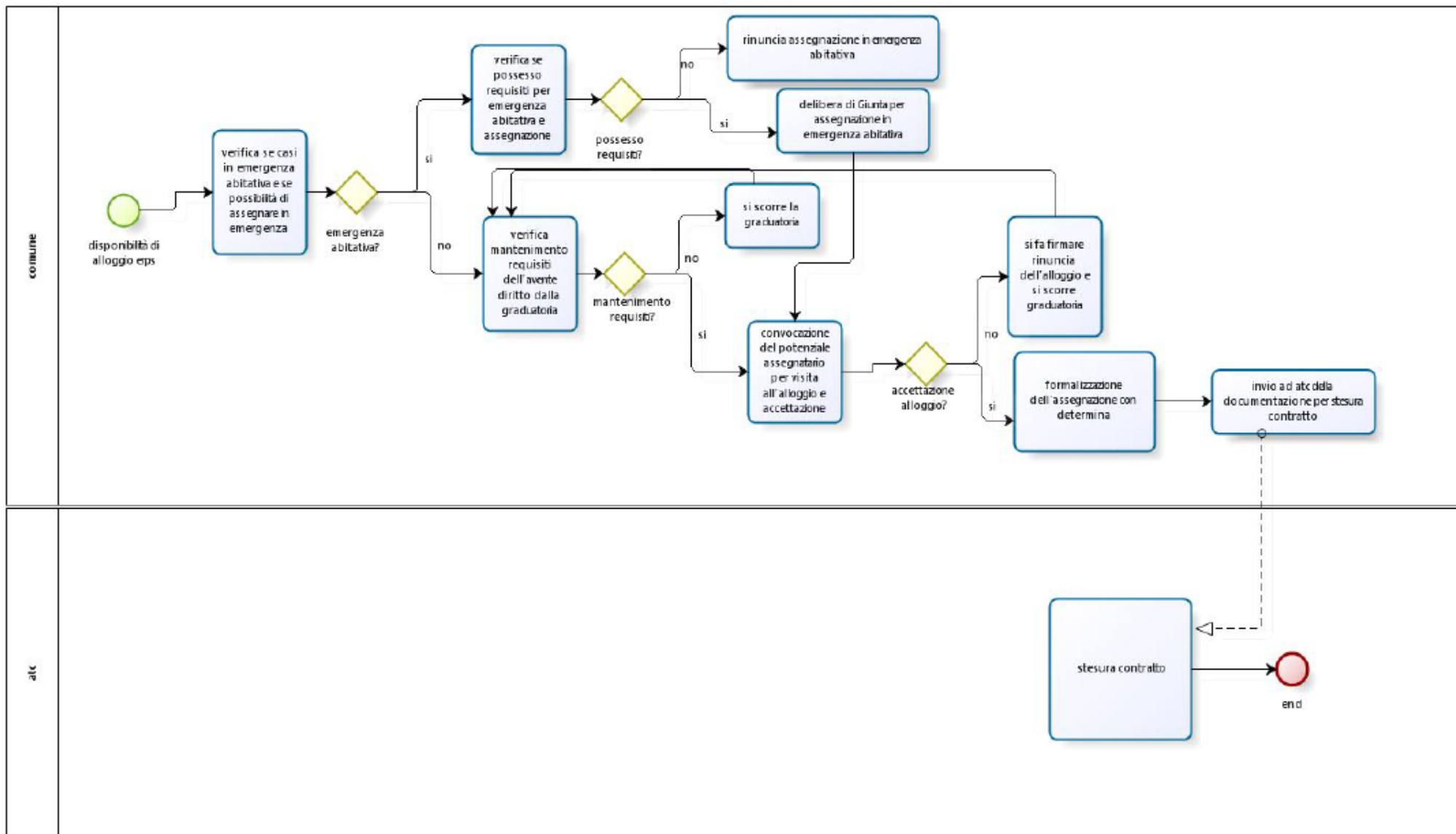

ASSEGNAZIONI ALLOGGI ERPS

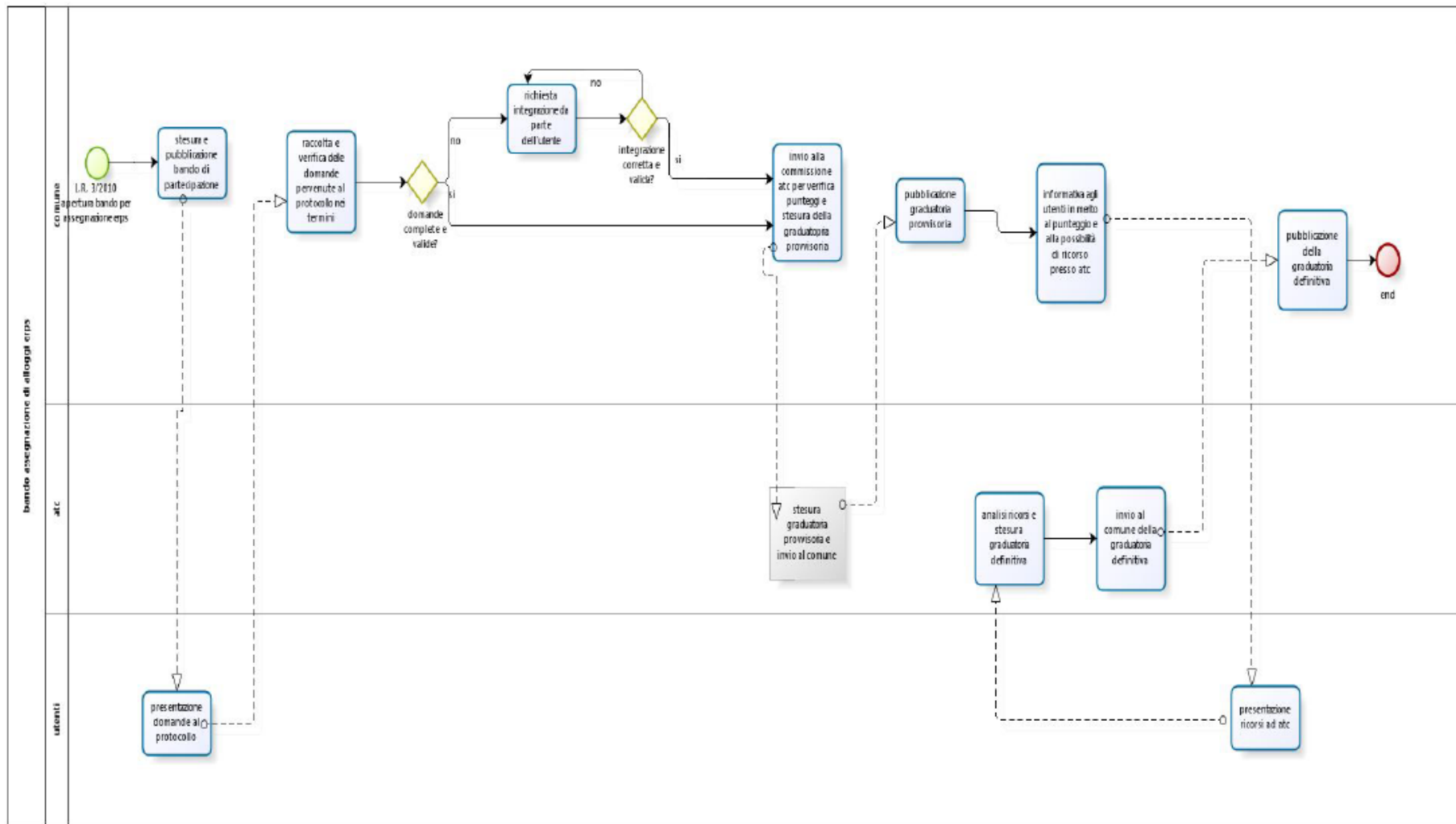

BANDO ASSEGNAZIONE ALLOGGI ERPS



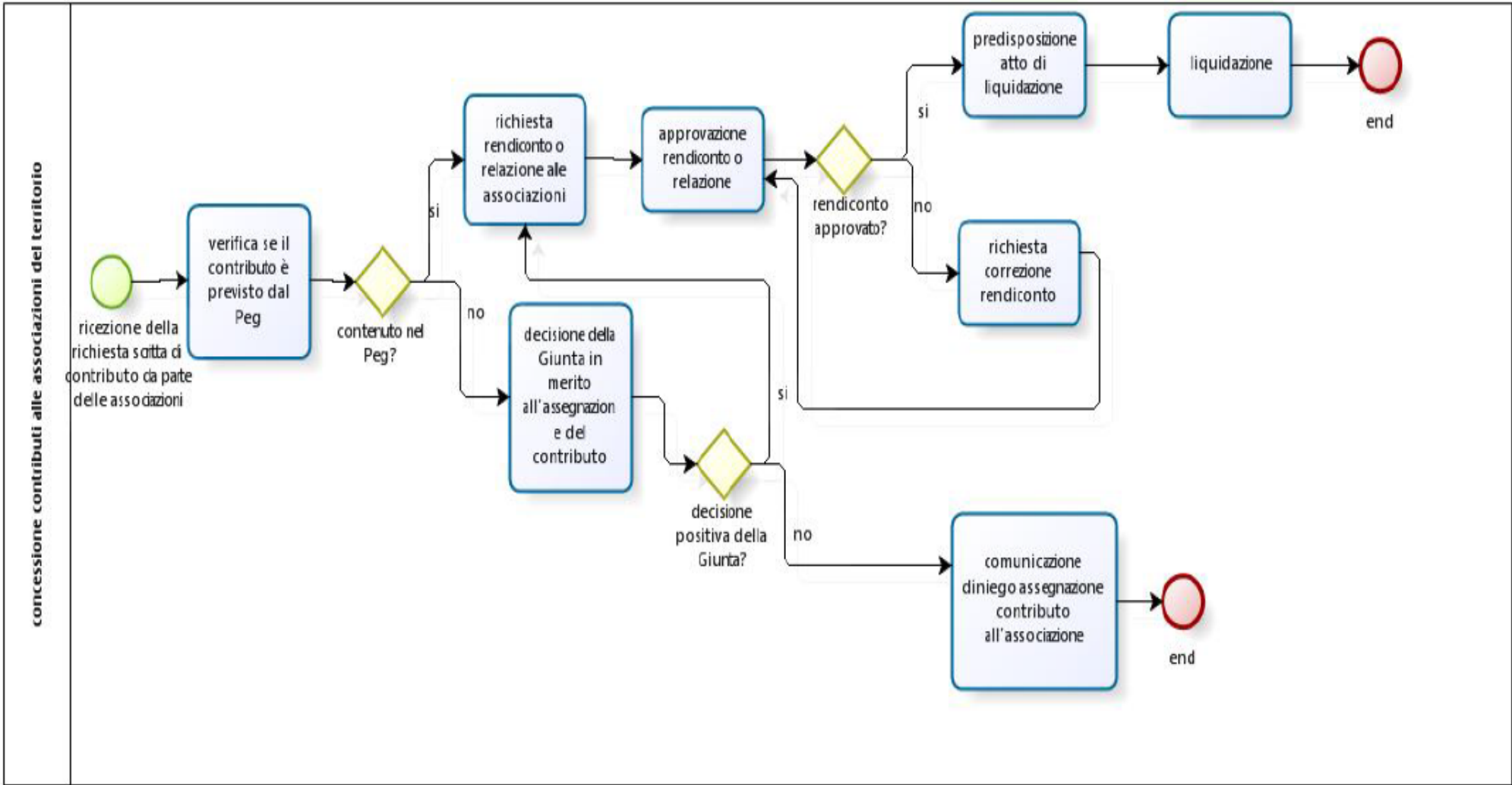

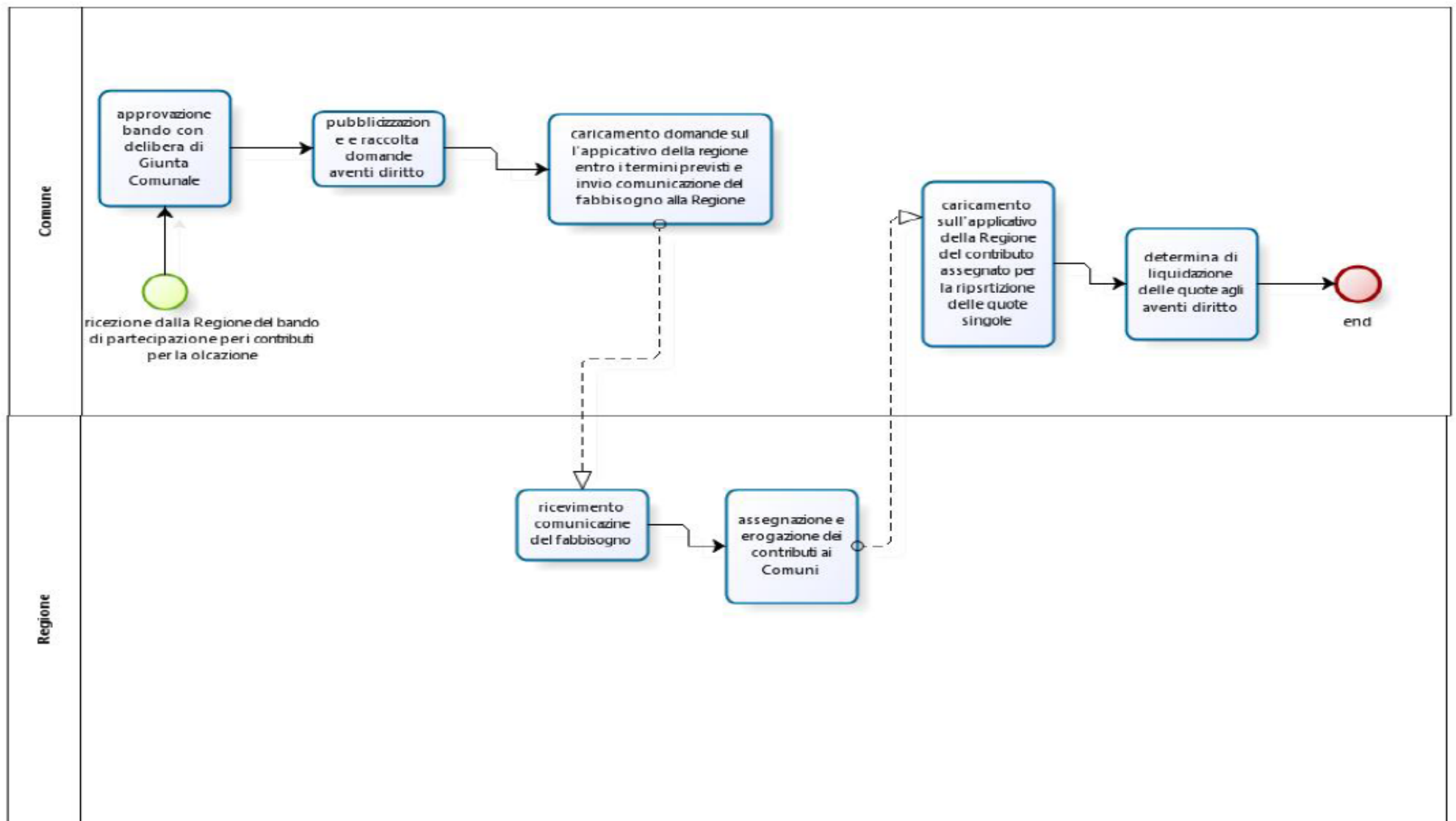

EROGAZIONE CONTRIBUTO PER IL SOSTEGNO DELLA LOCAZIONE ALLA REGIONE

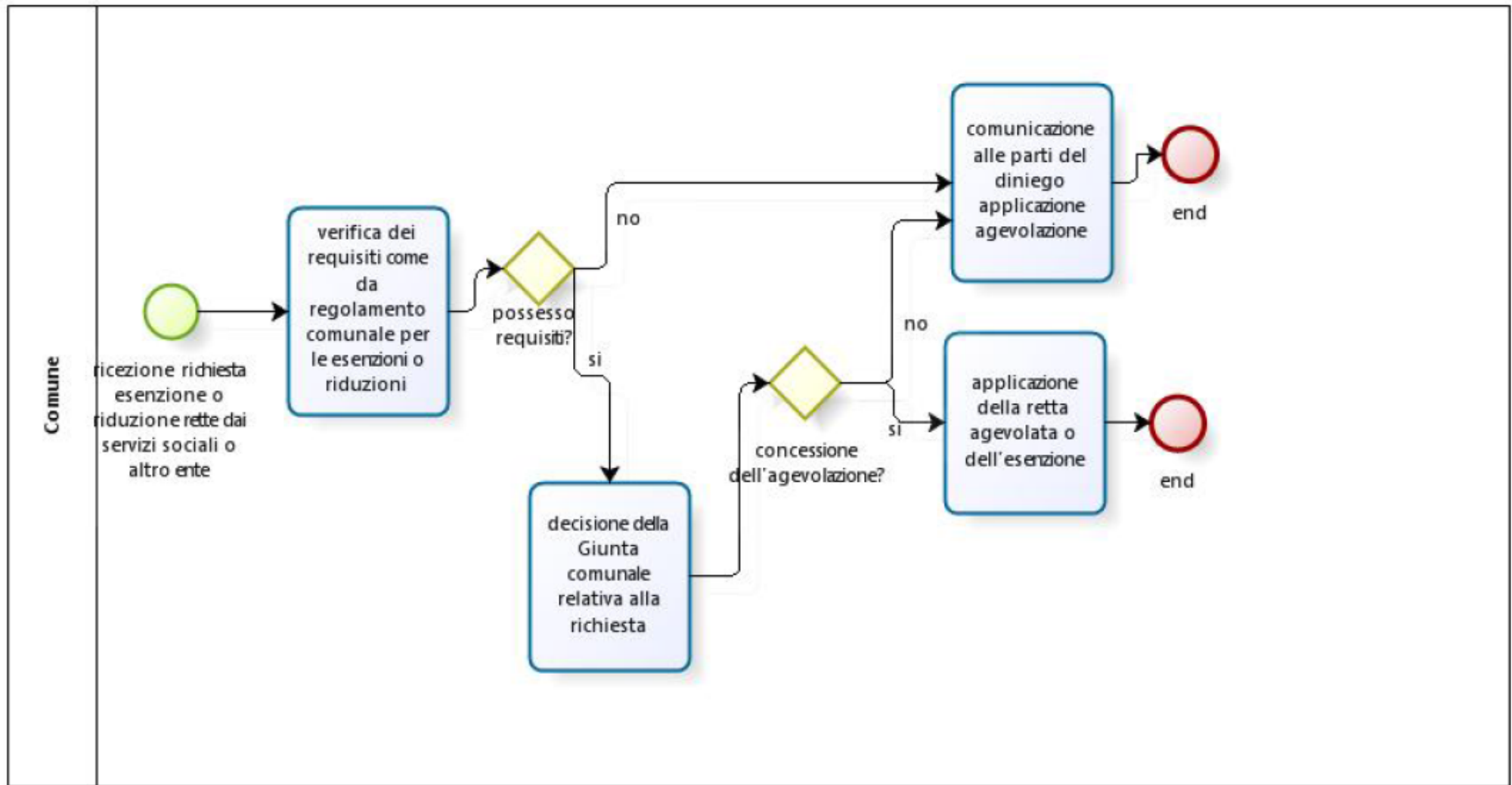

RIDUZIONE ESENZIONE RETTE ASILO NIDO

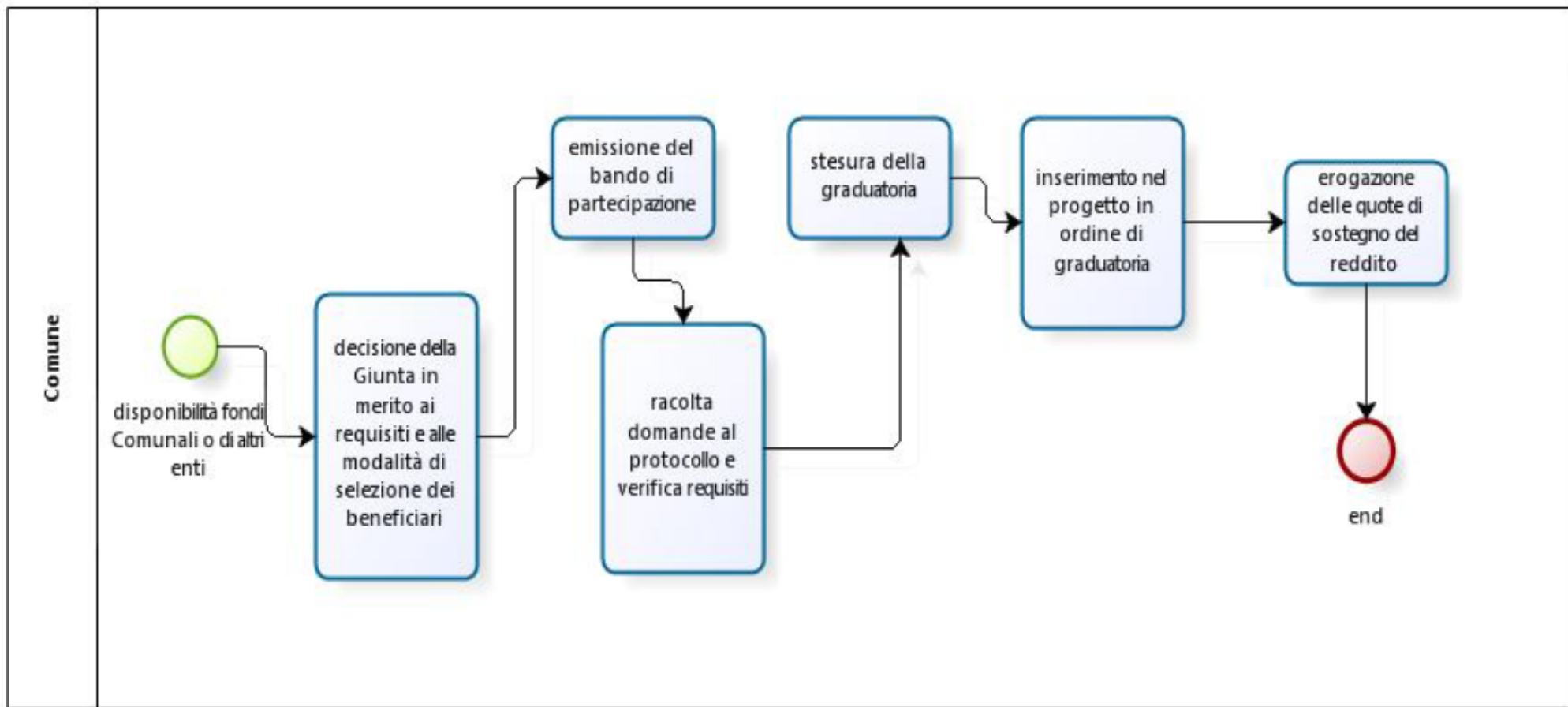

SELEZIONE PARTECIPANTI A PROGETTO SOSTEGNO DEL REDDITO

# 1 MOBILITÀ

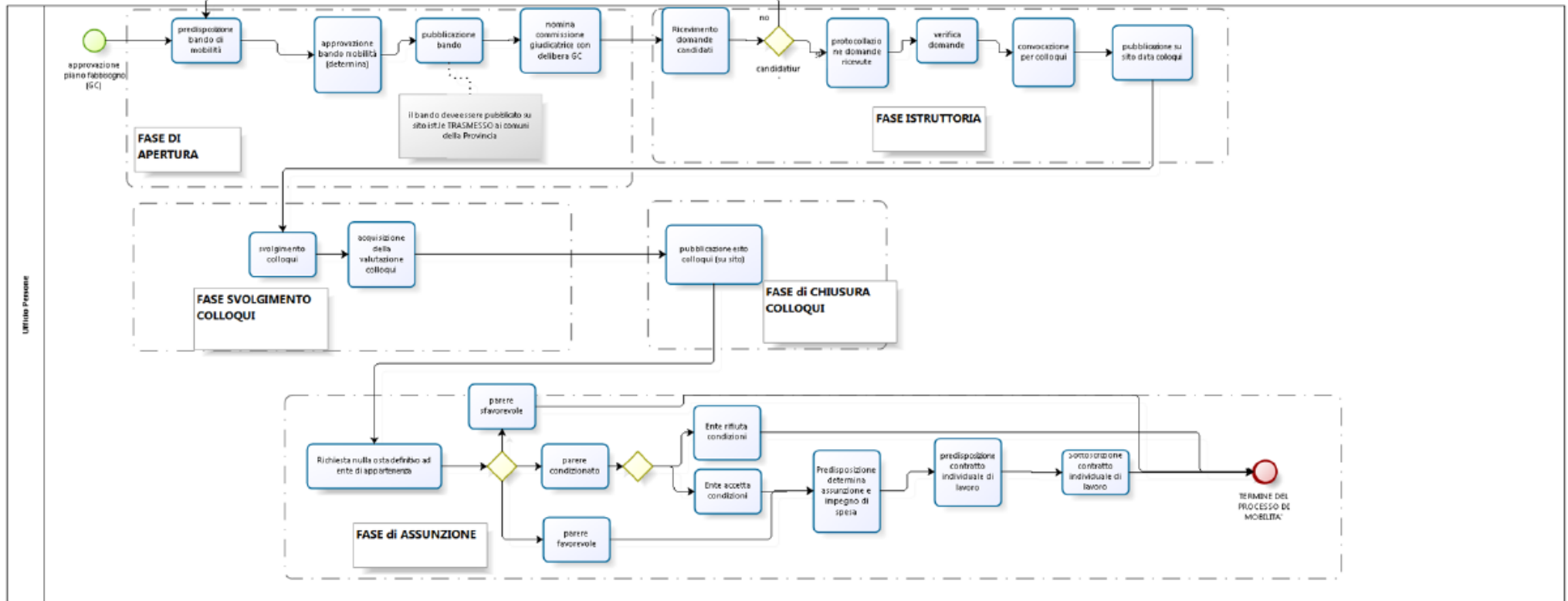

# 1 PUBBLICO CONCORSO

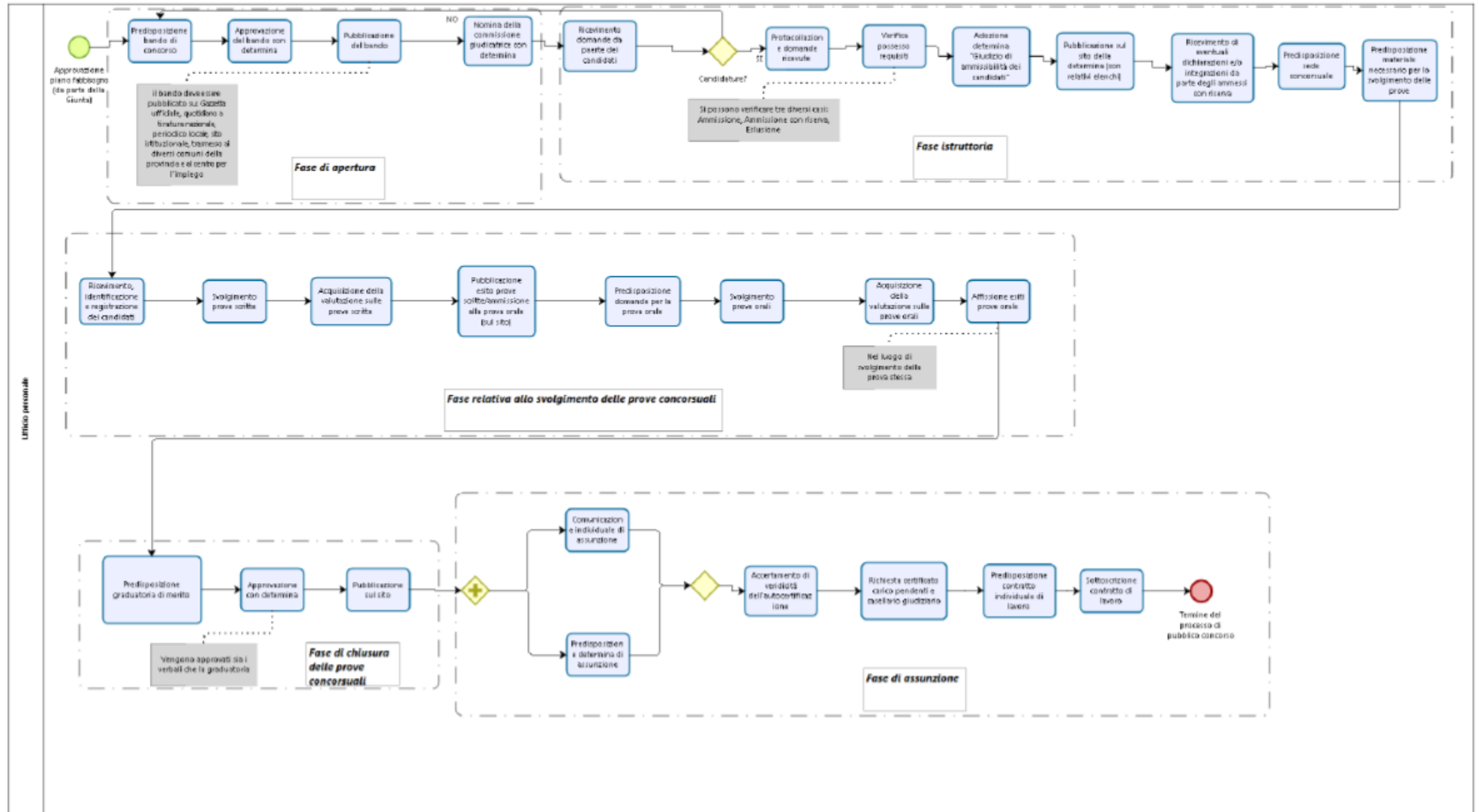

# 1 ASSUNZIONE TRAMITE CENTRO IMPIEGO

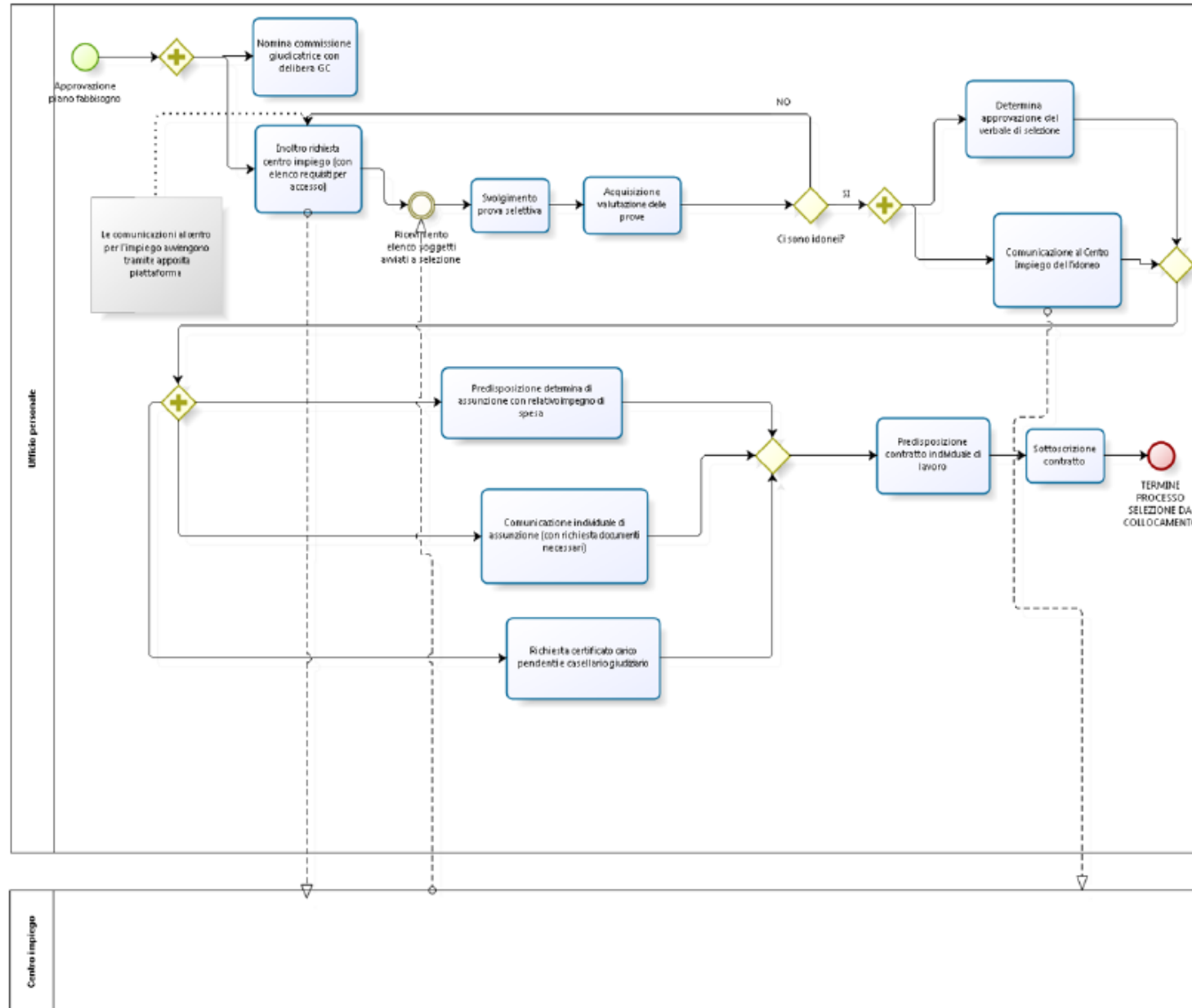

# 1 ATTRIBUZIONE PROGRESSIONE ORIZZONTALE

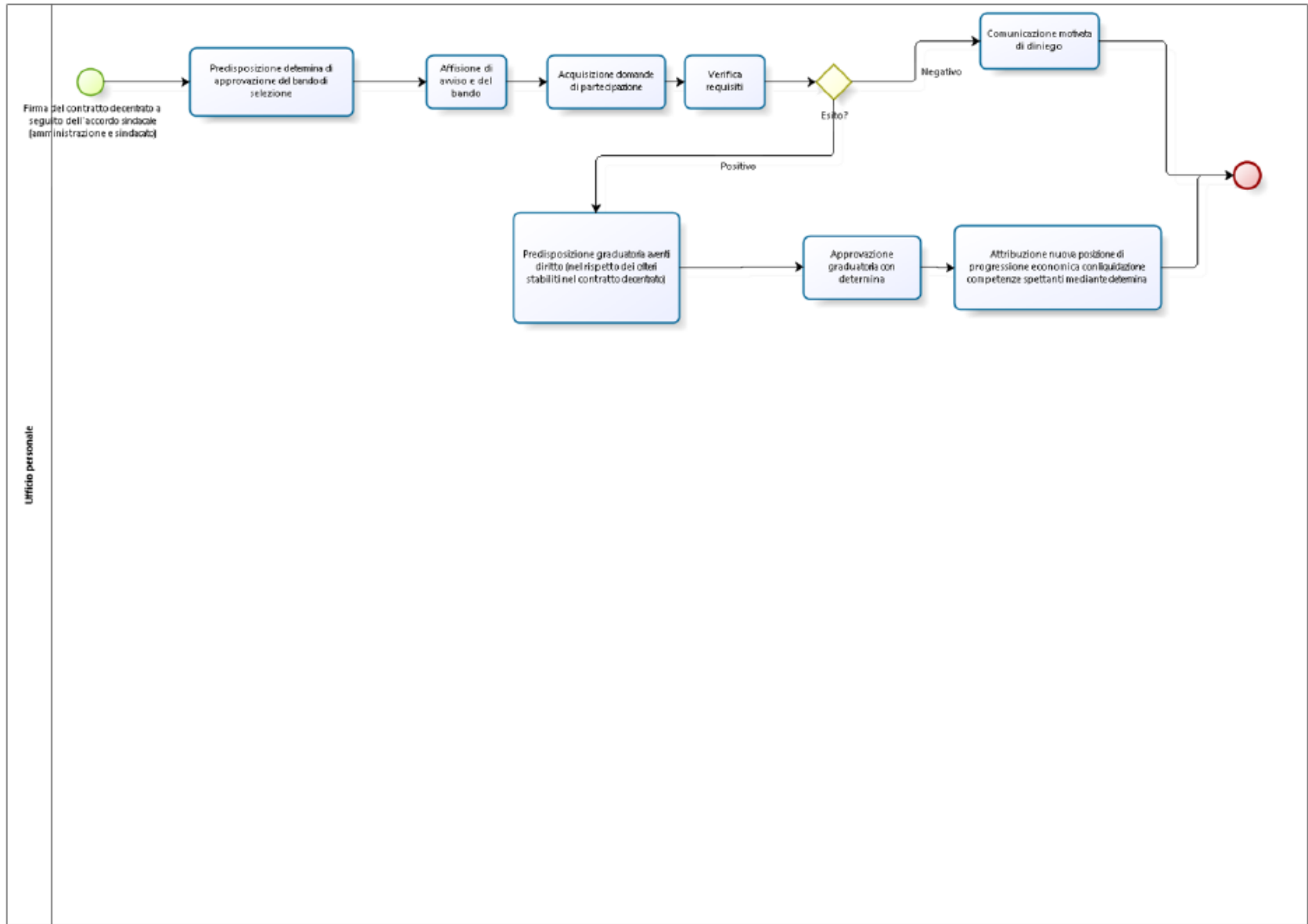



# 1 INDIVIDUAZIONE SEGRETARIO COMUNALE

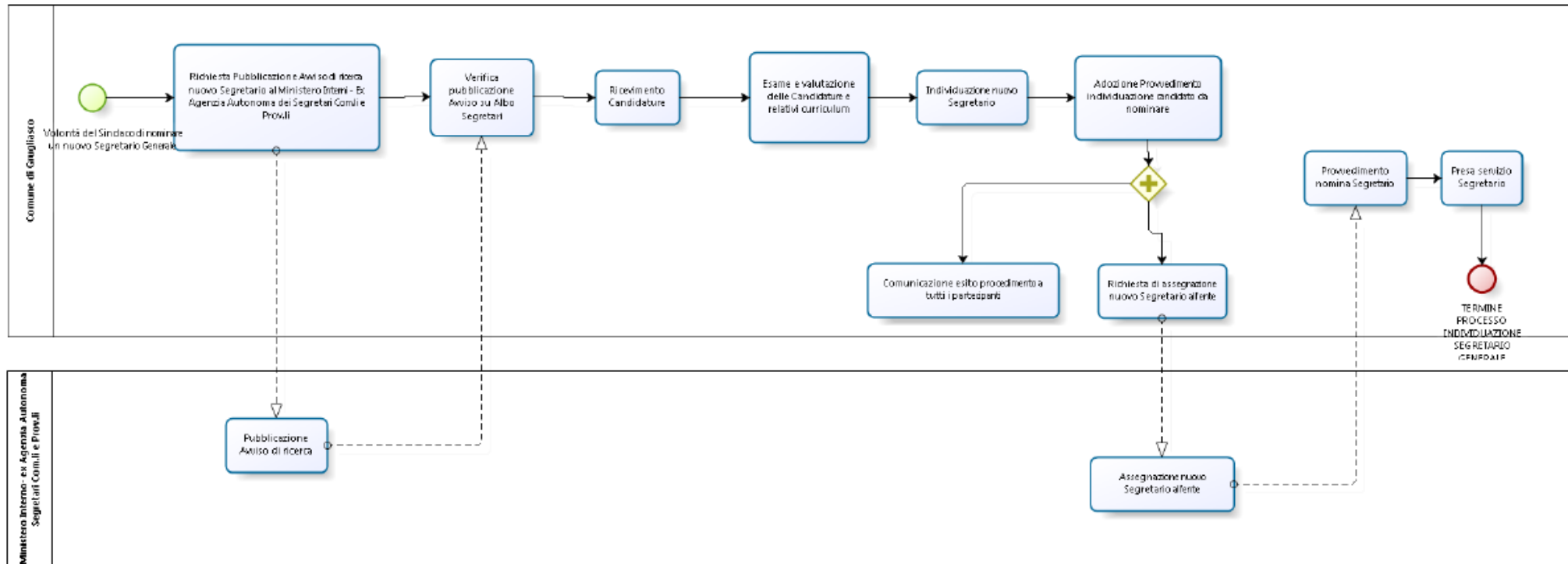

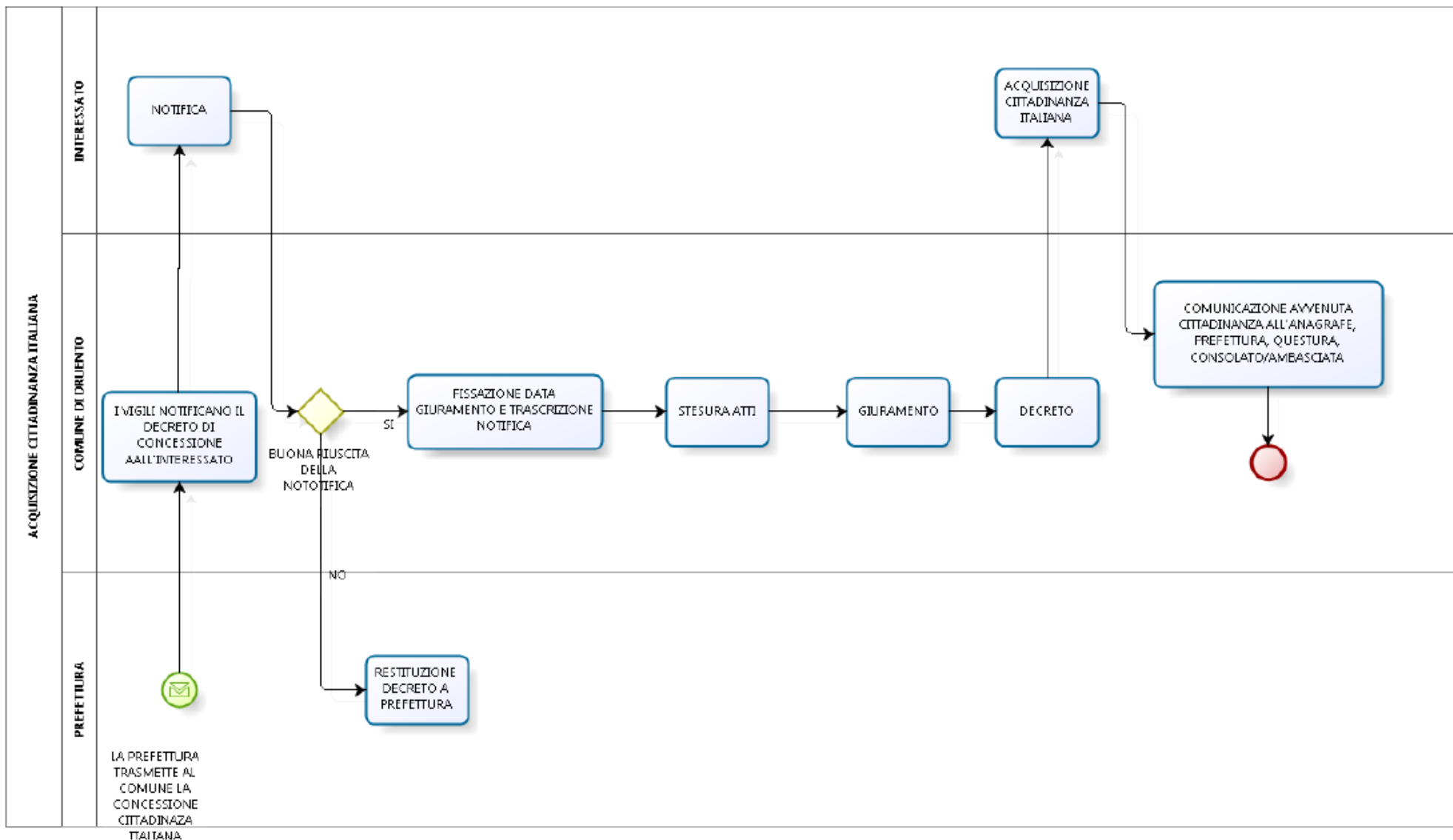

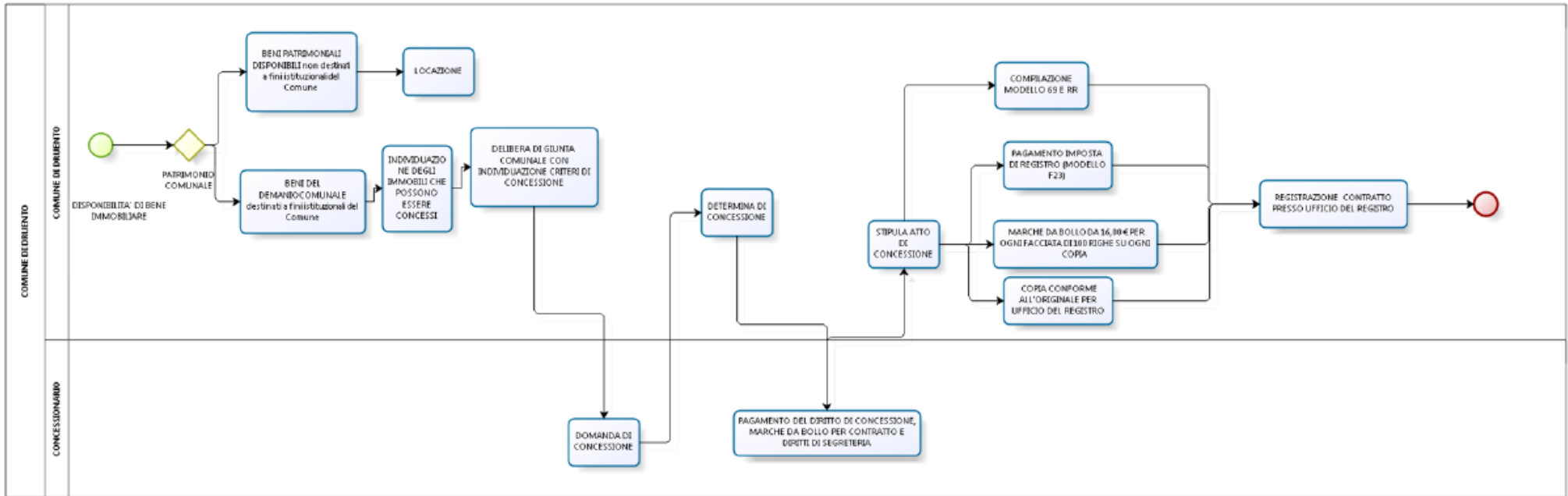

CONCESSIONI

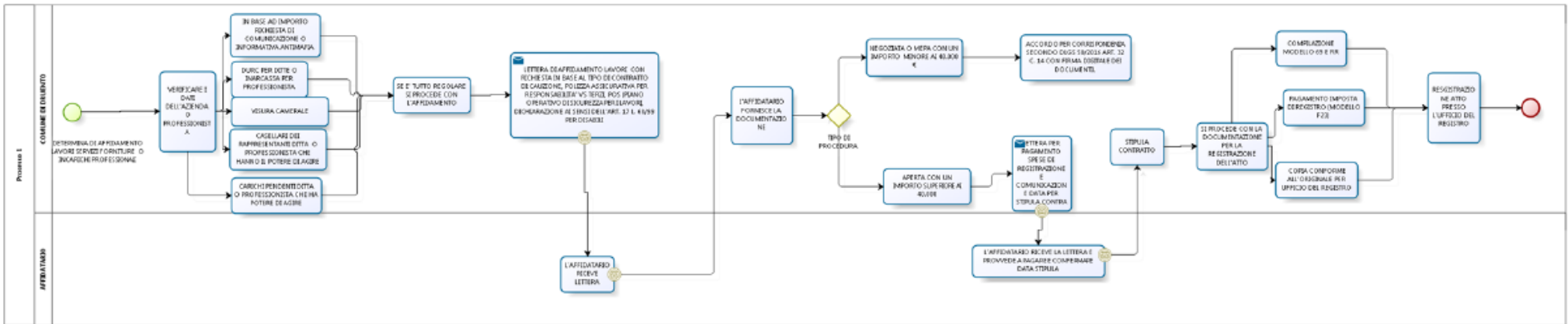

## CONTRATTI

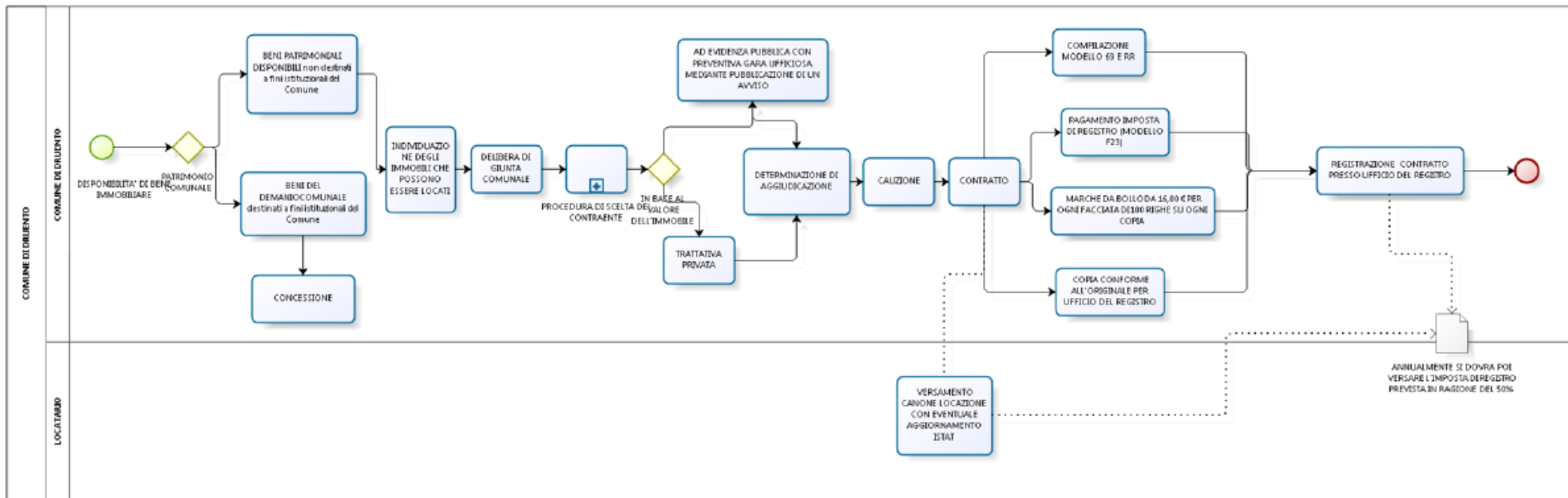

## LOCAZIONE

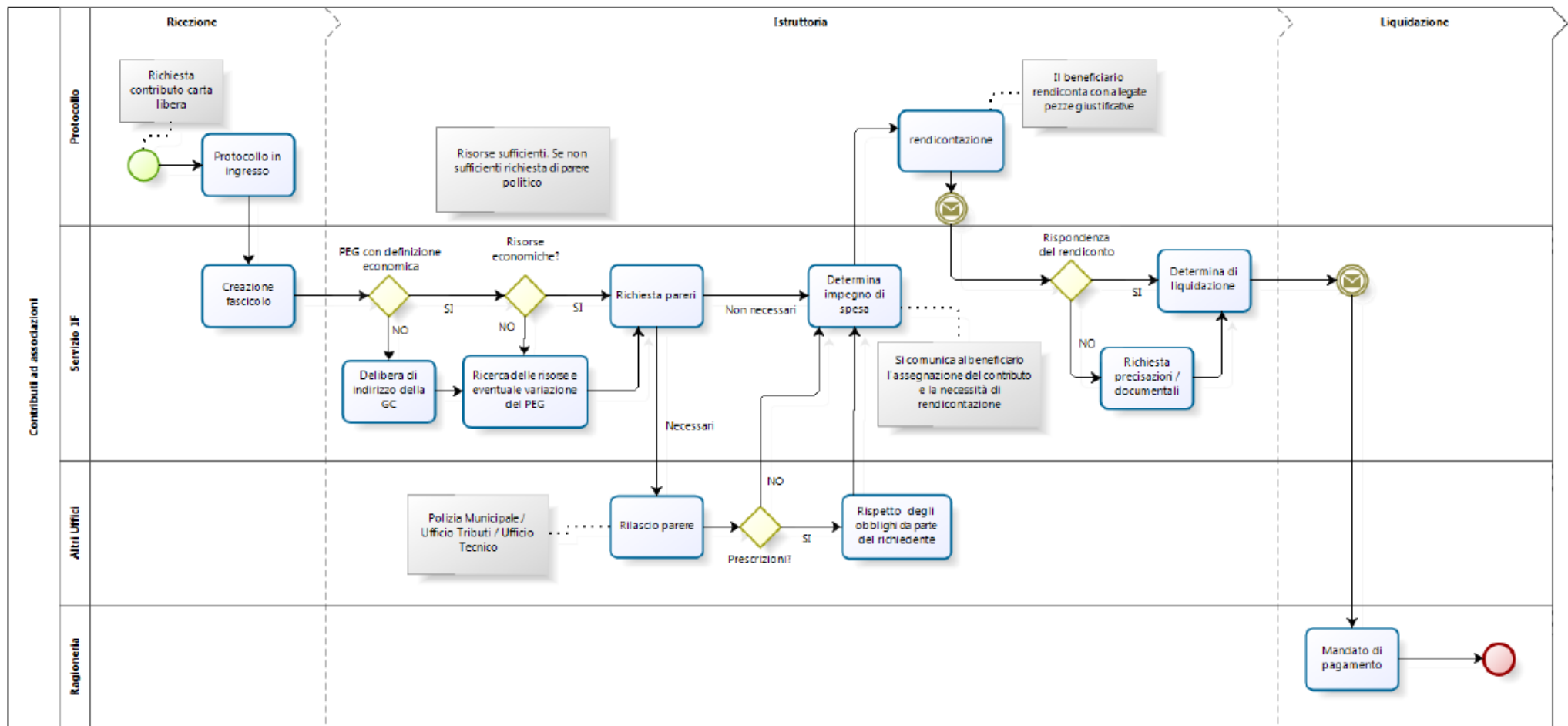

# 1 PROCEDURA NEGOZIATA

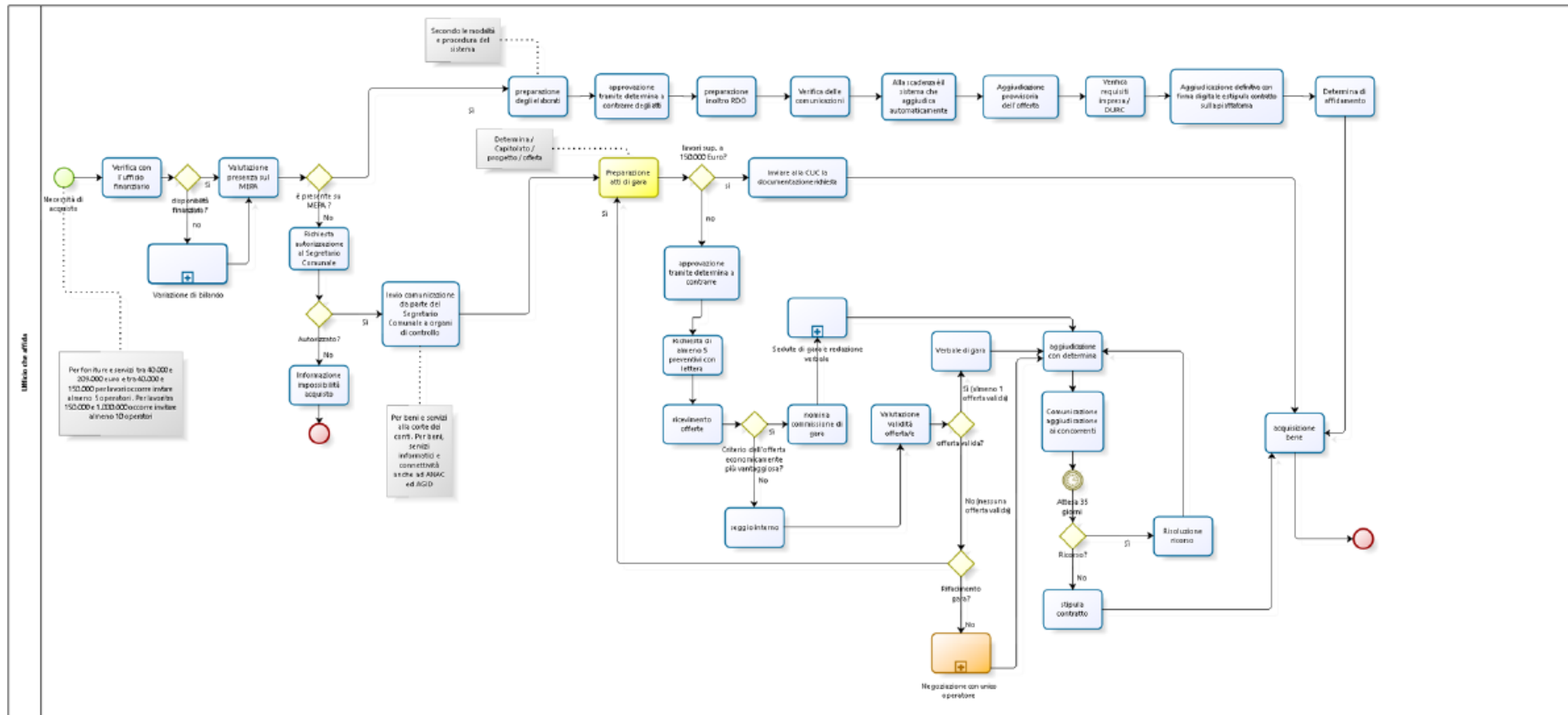

# 1 AFFIDAMENTO DIRETTO SERVIZI FORNITURE E LAVORI IN VIA ORDINARIA FINO A 40.000

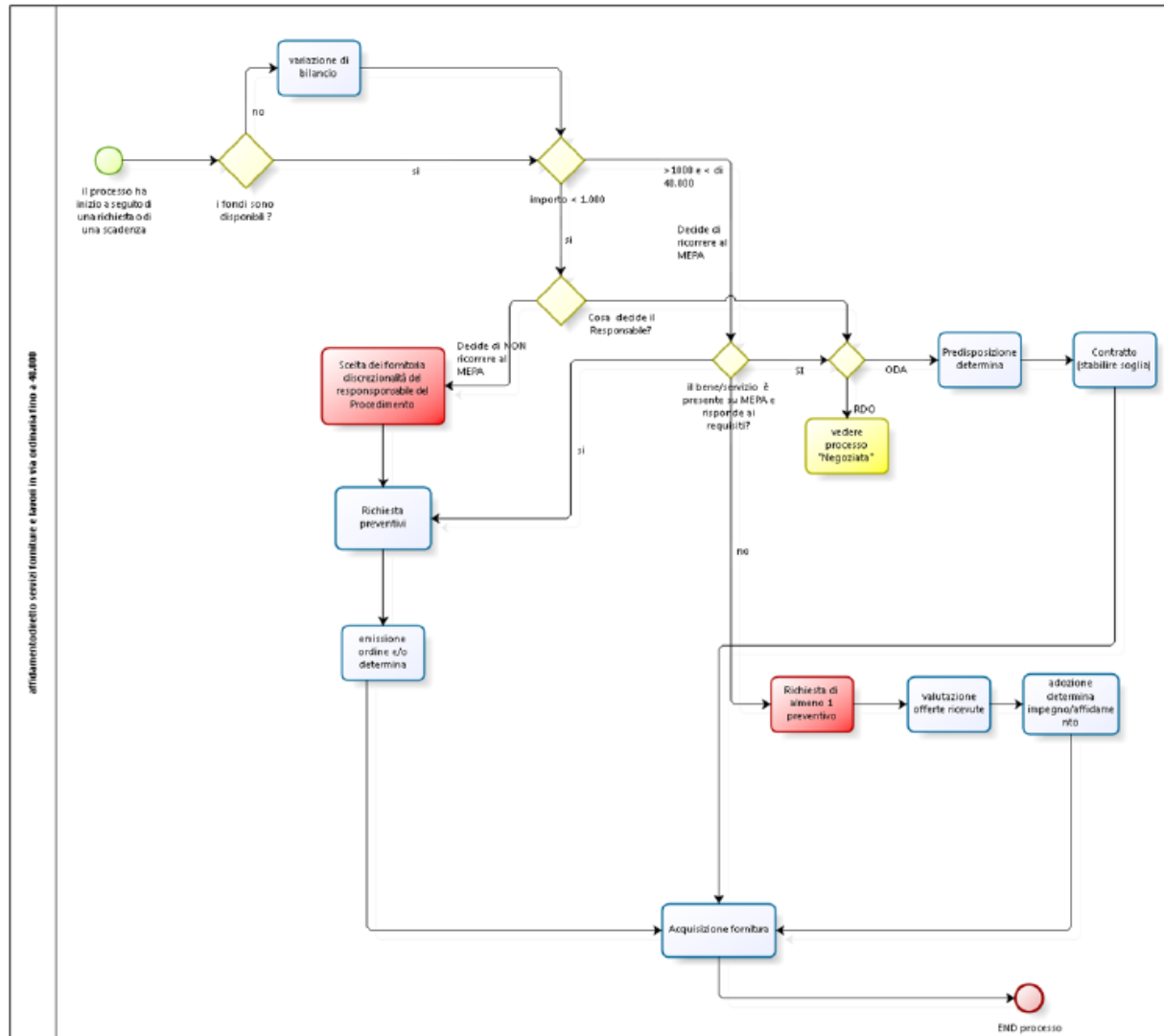



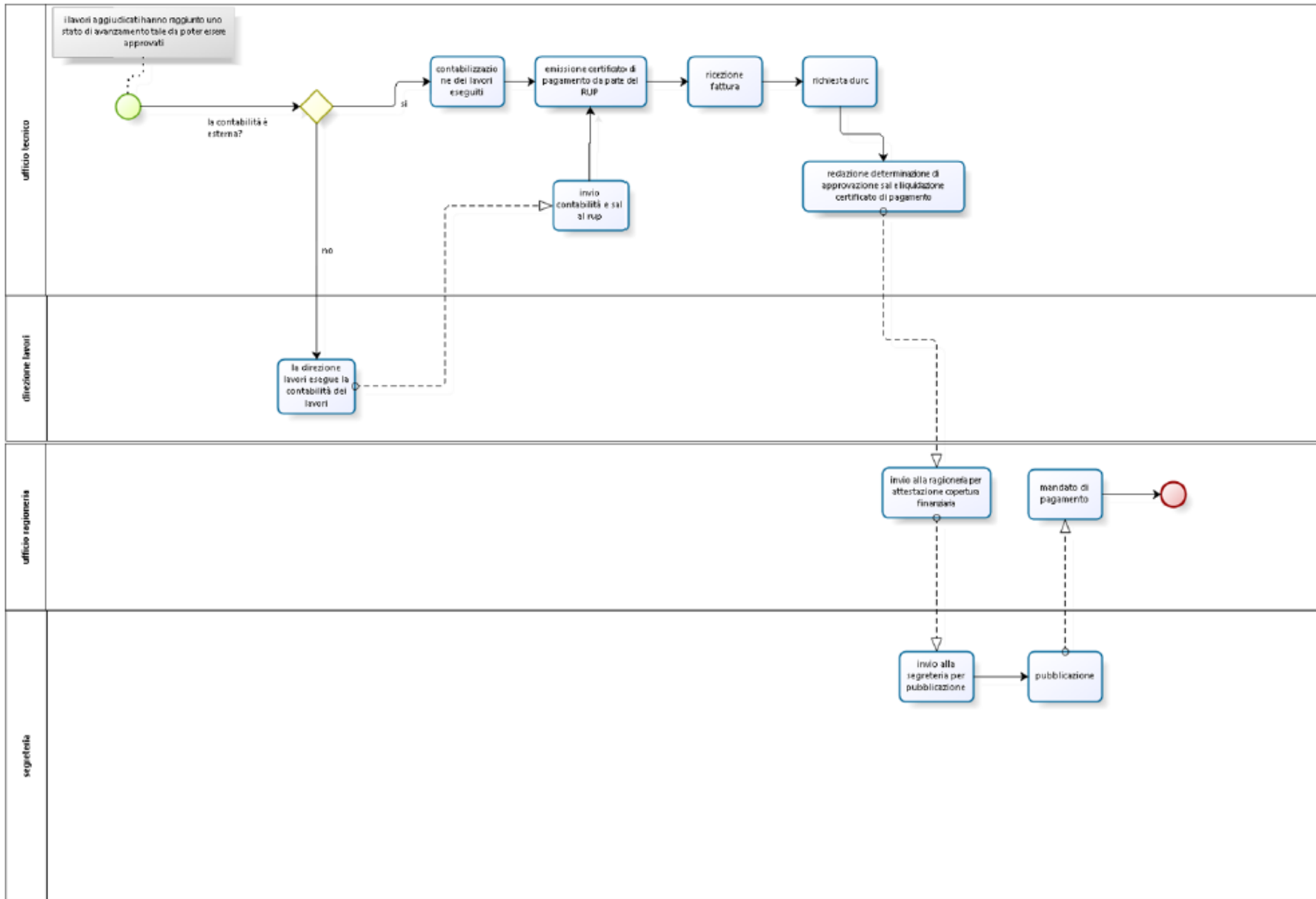



# 1 Procedura aperta

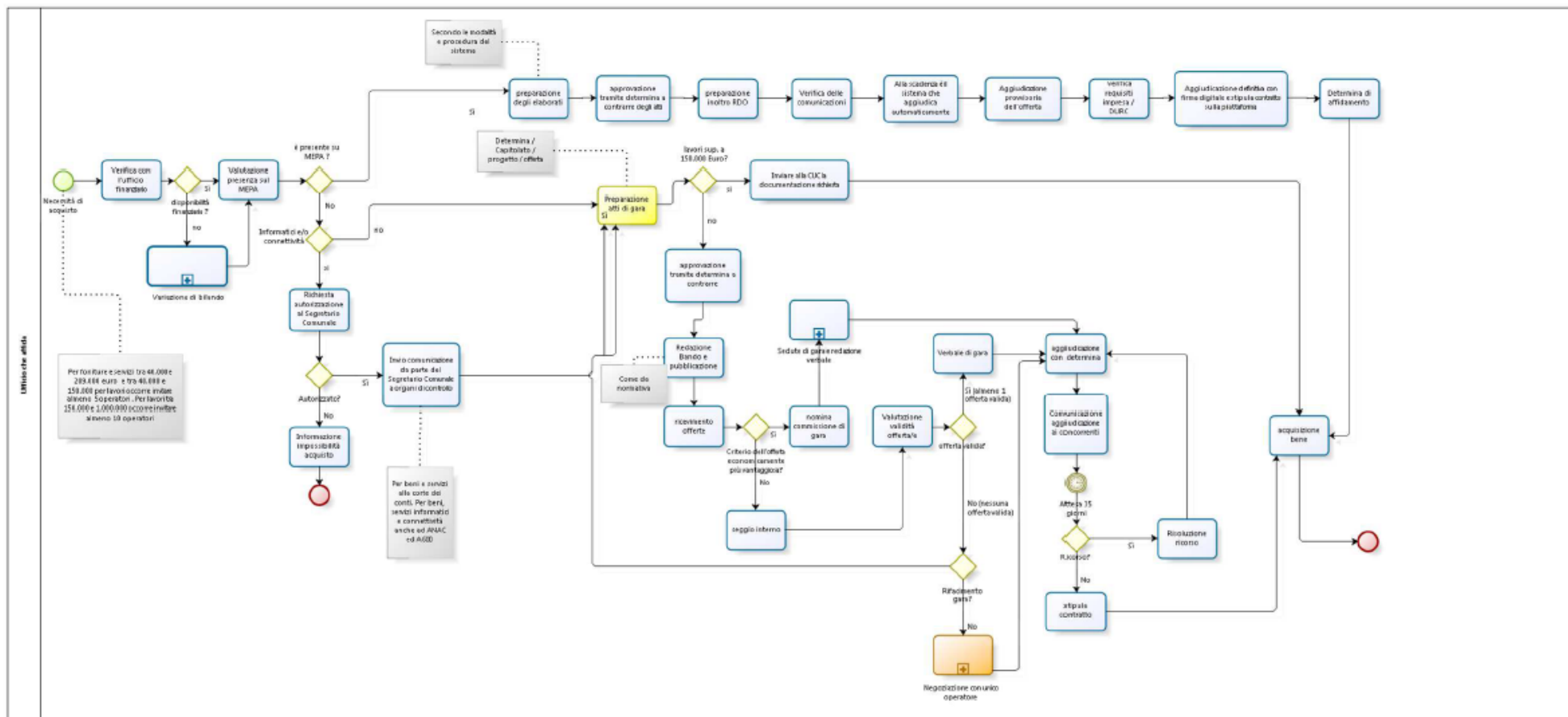

# 1 Procedura ristretta

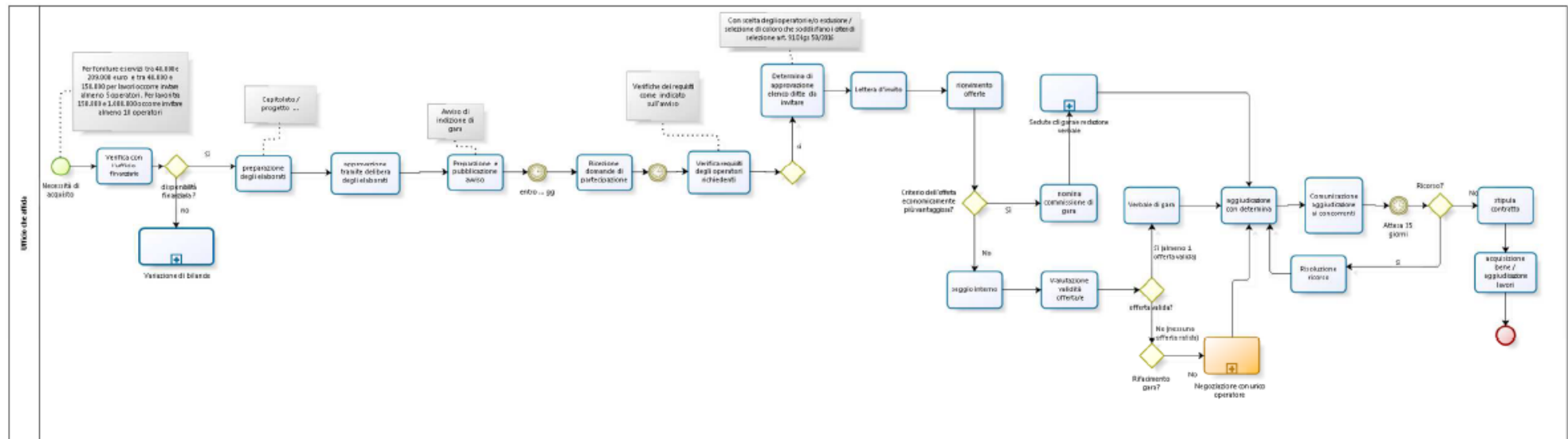

# 1 PROCEDURA SOPRA SOGLIA

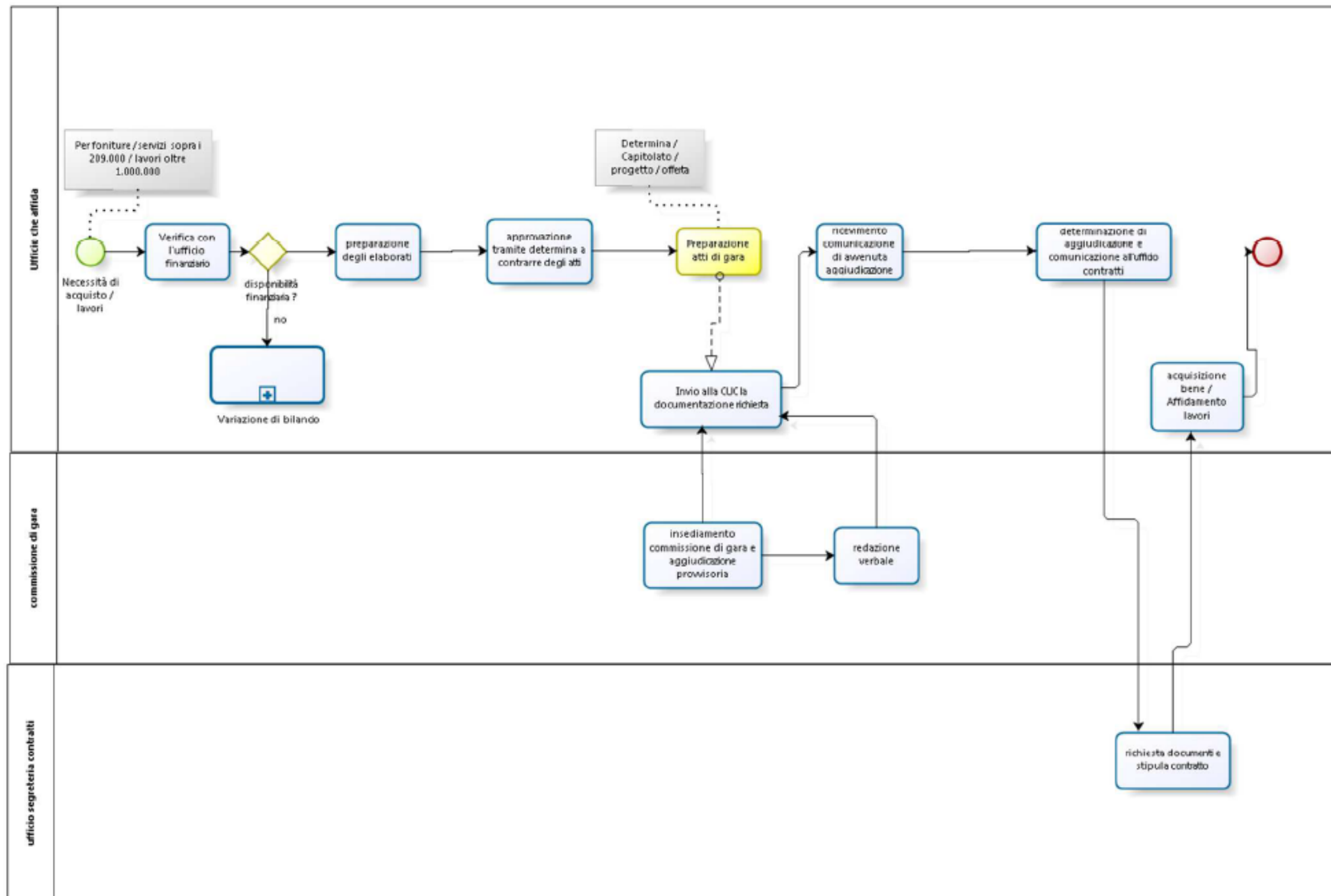

# 1 DIAGRAMMA 1

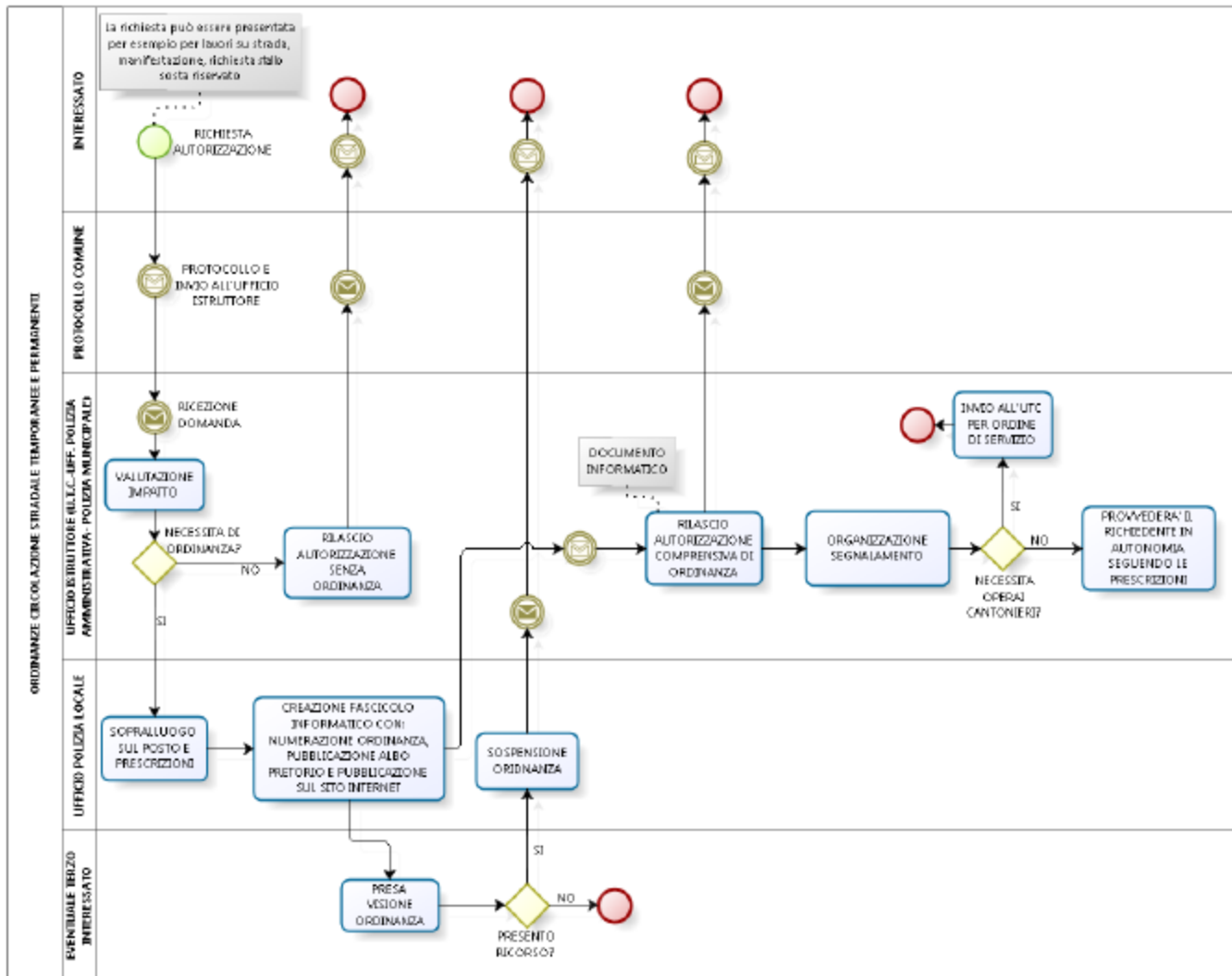

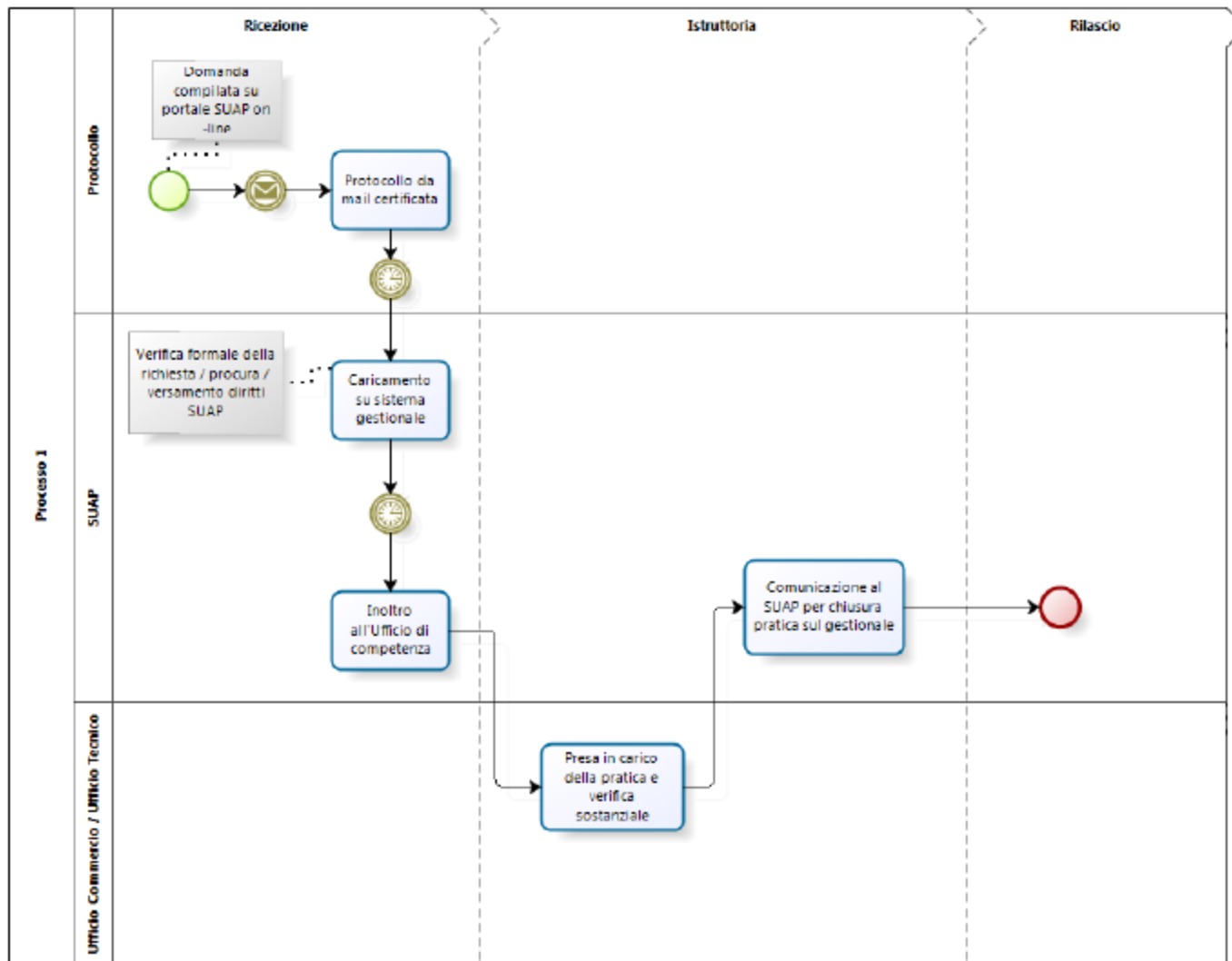

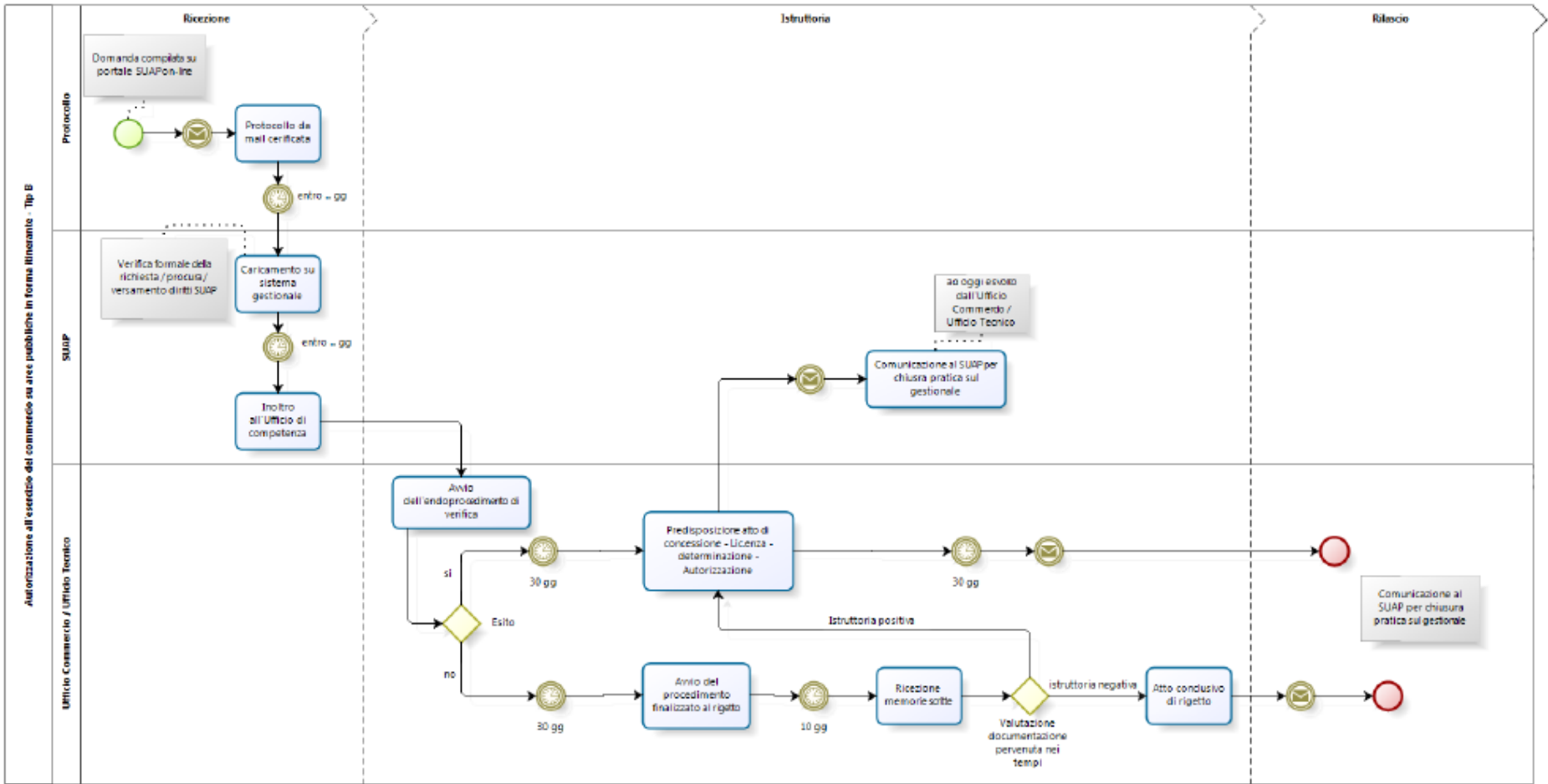



# 1 DIAGRAMMA 1

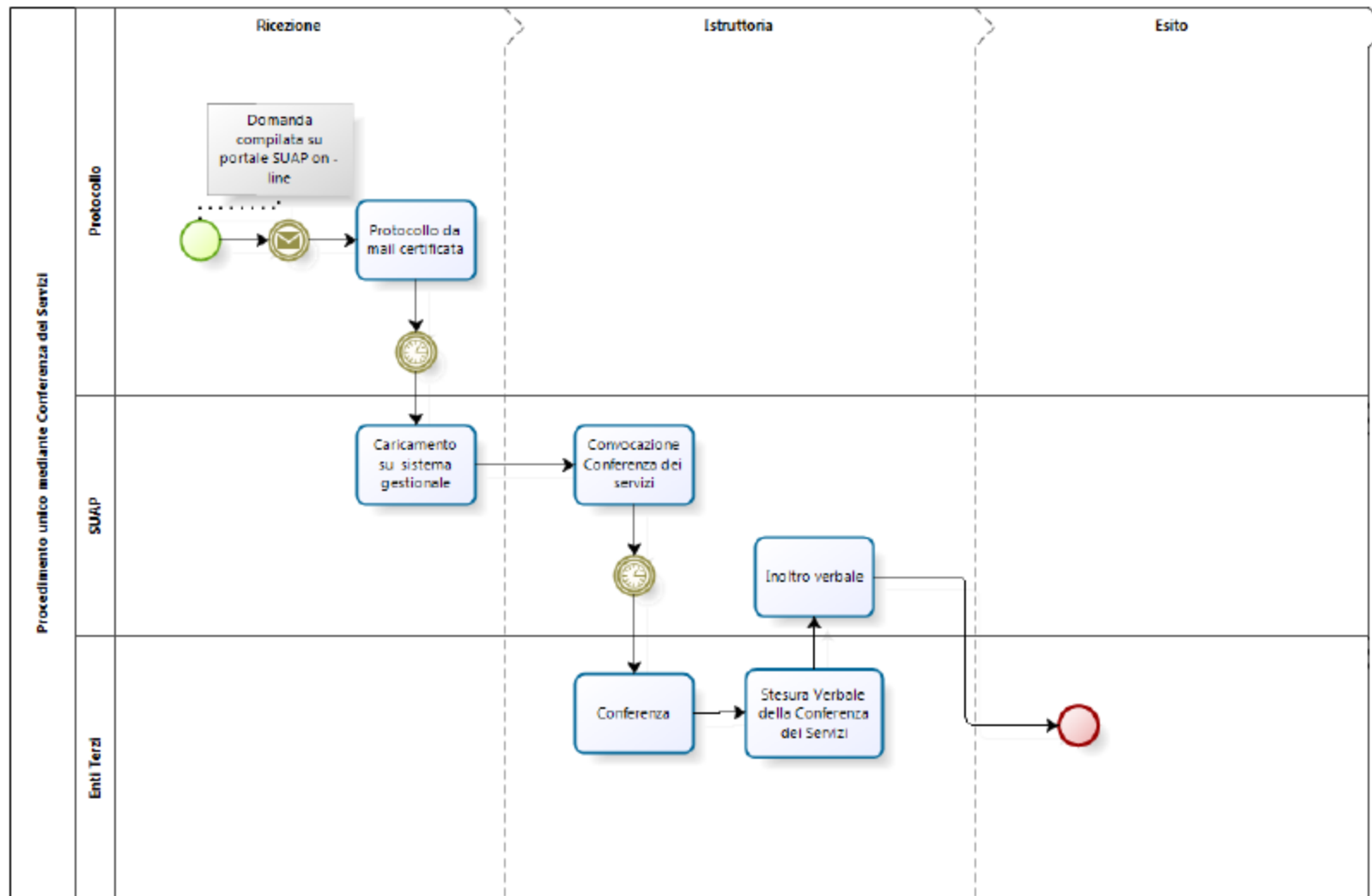

# 1 DIAGRAMMA 1

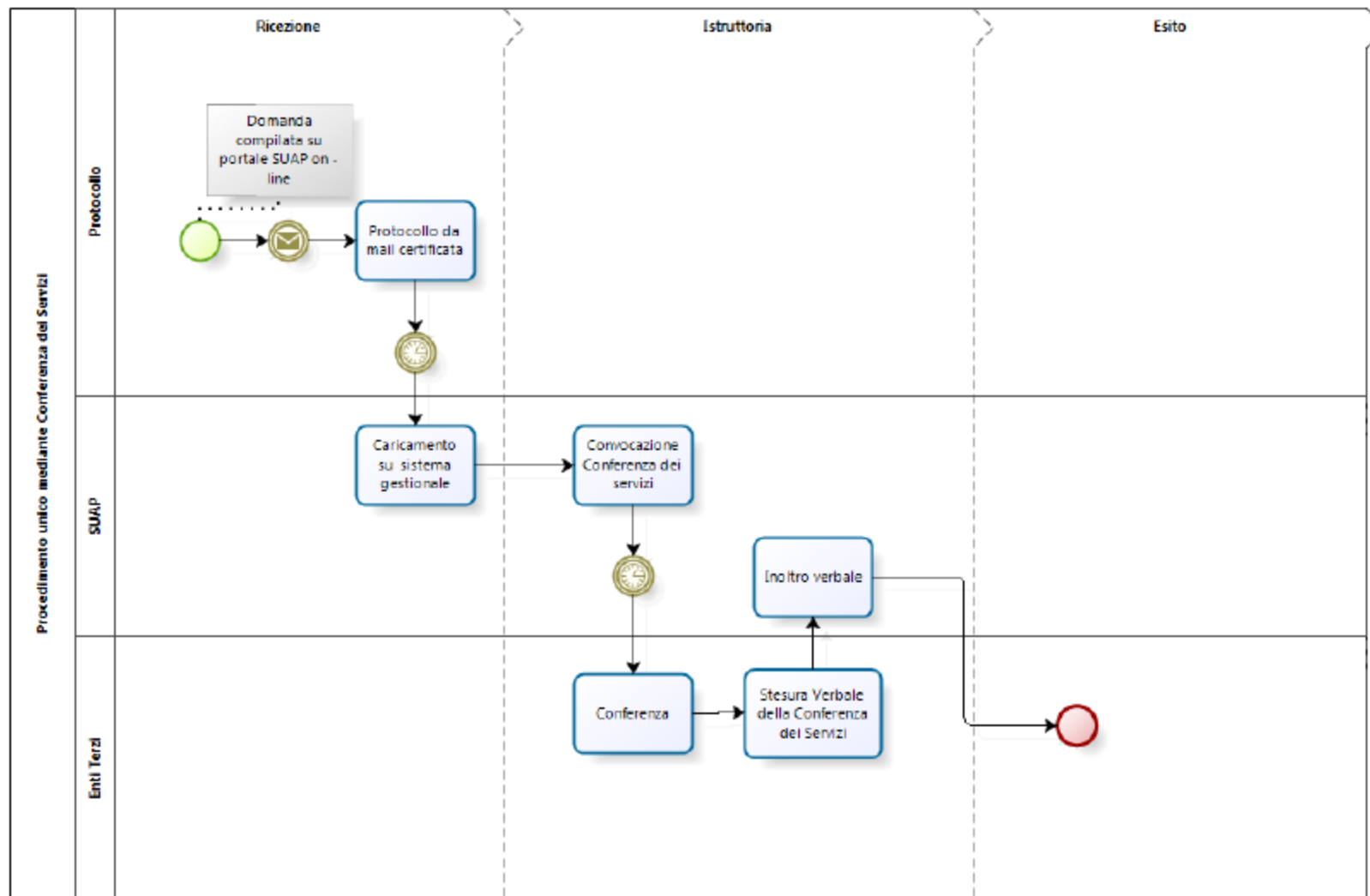

# 1 DIAGRAMMA 1

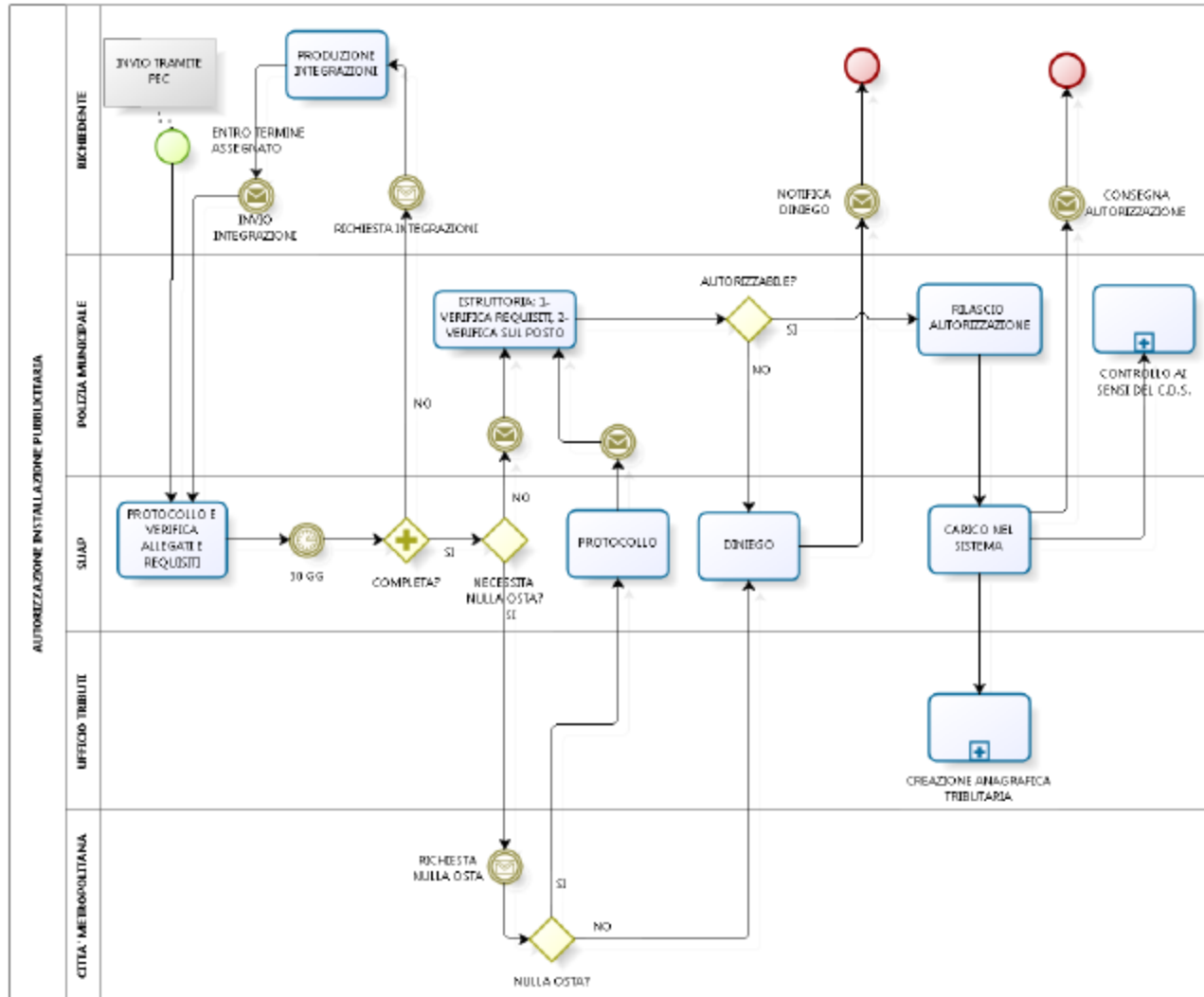

# 1 DIAGRAMMA 1

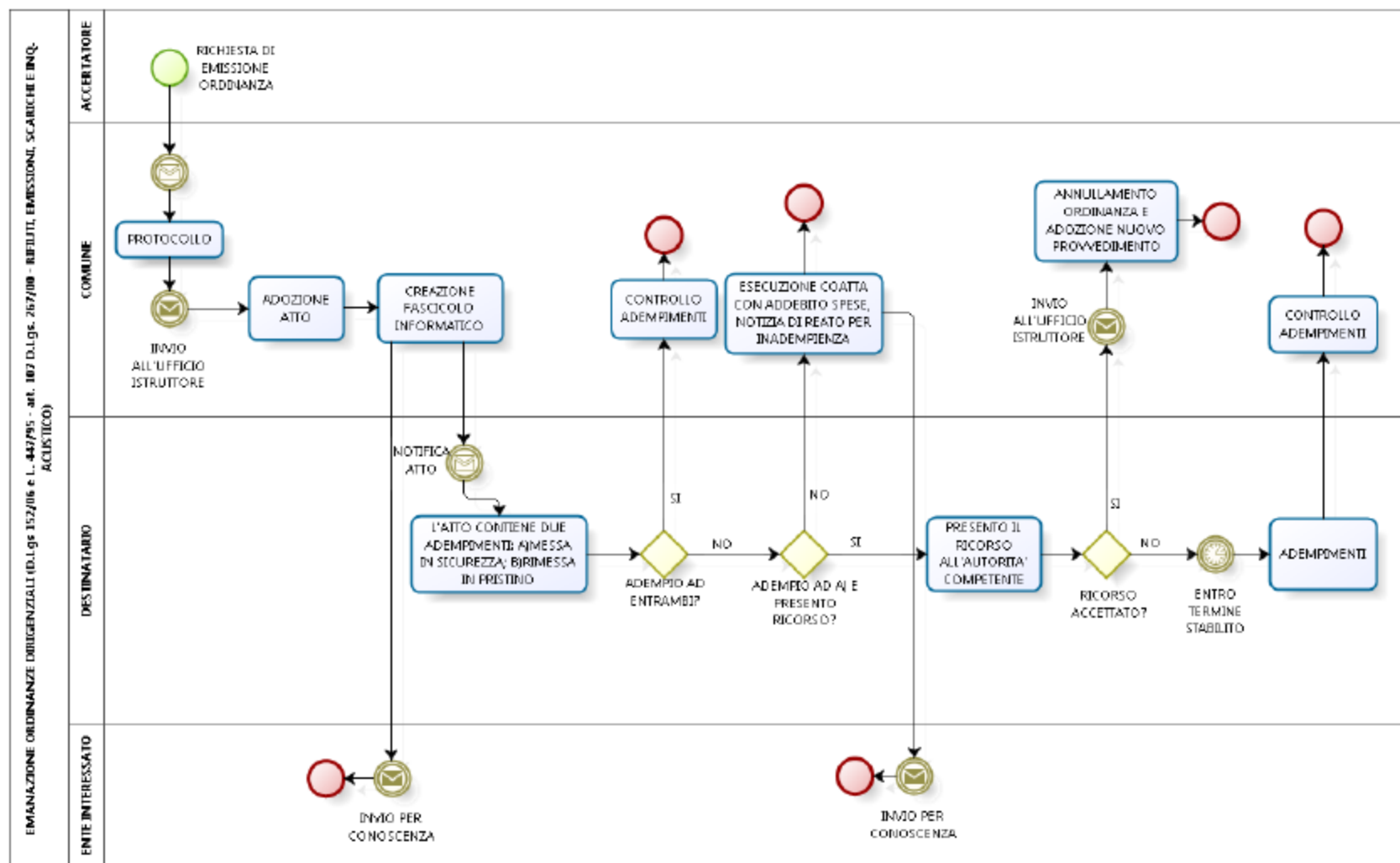

# 1 DIAGRAMMA 1

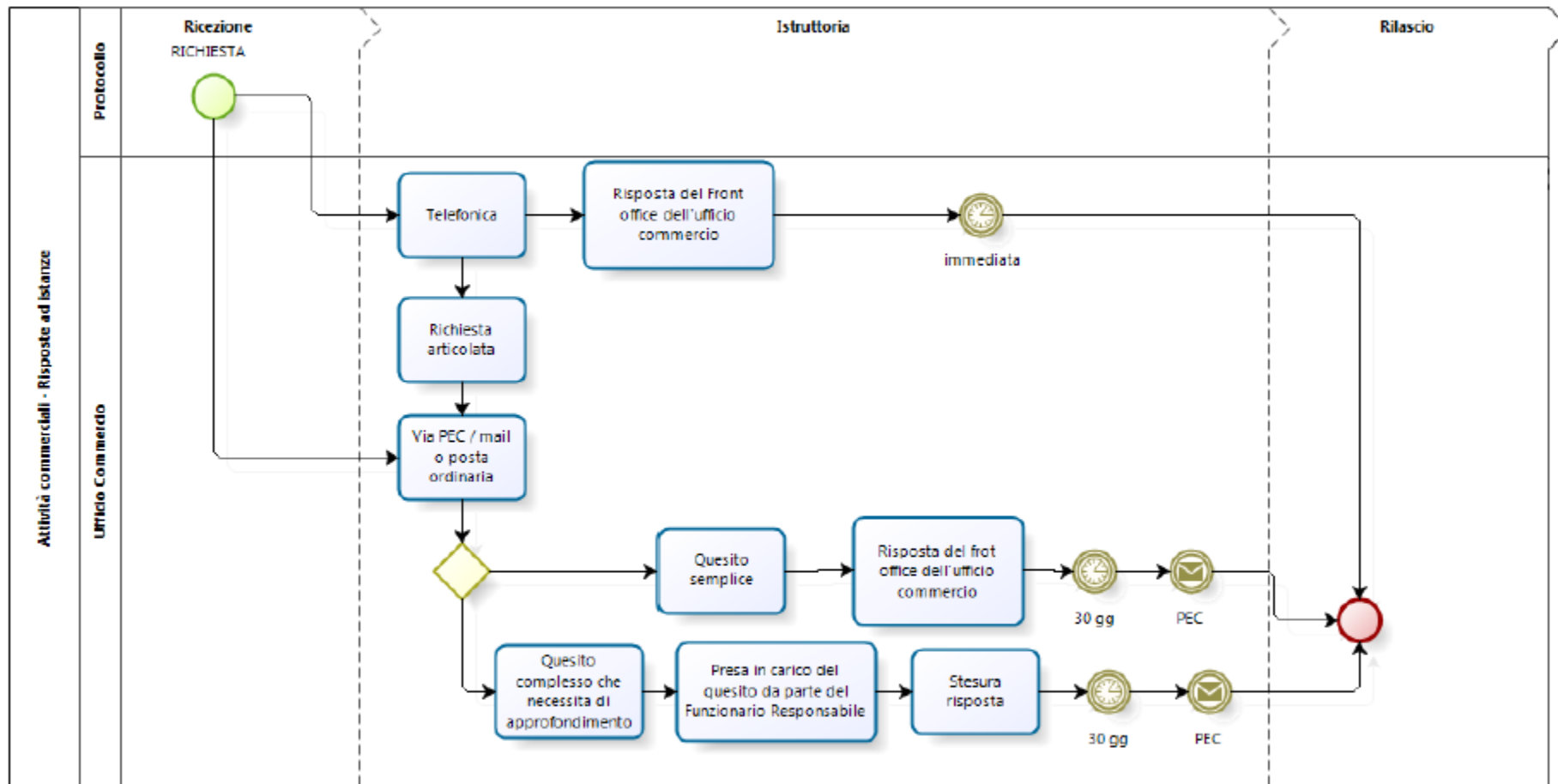

# 1 DIAGRAMMA 1

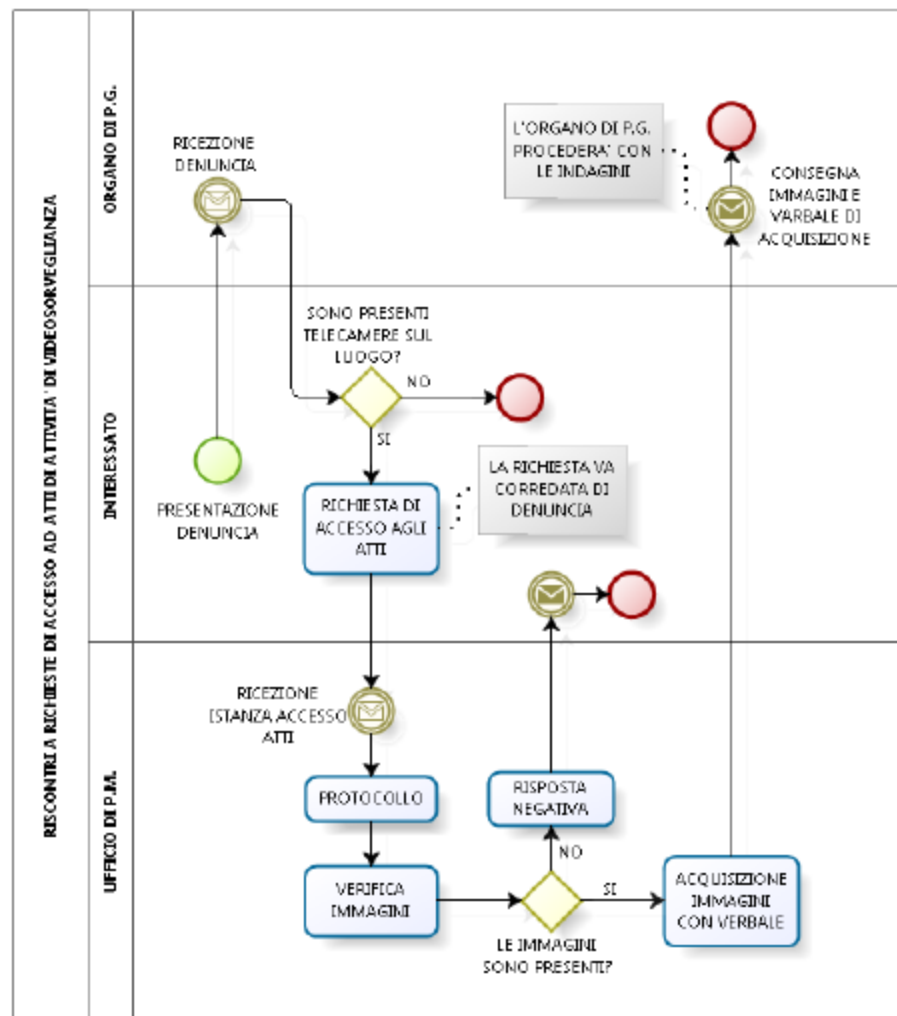

# 1 DIAGRAMMA 1

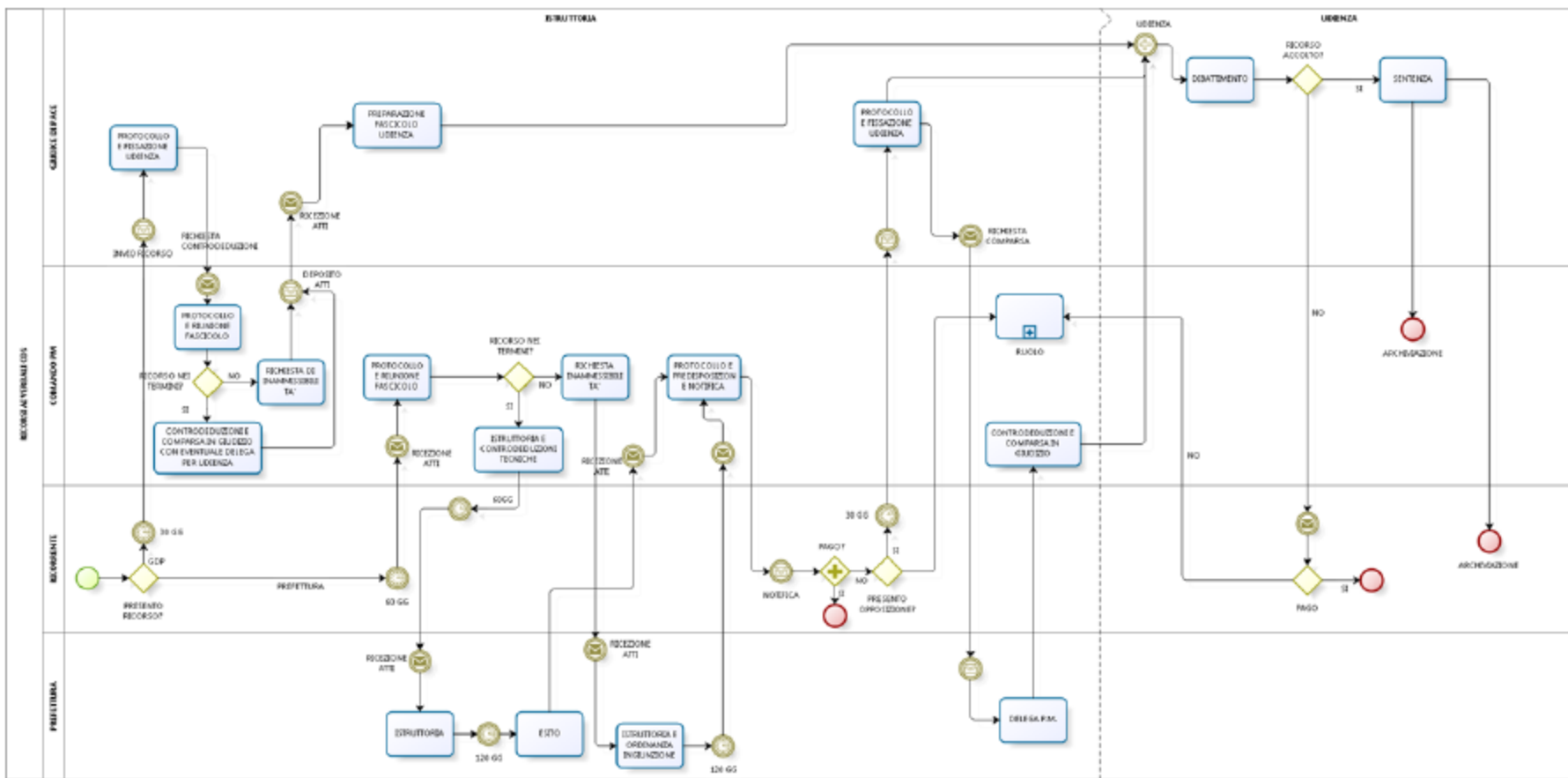

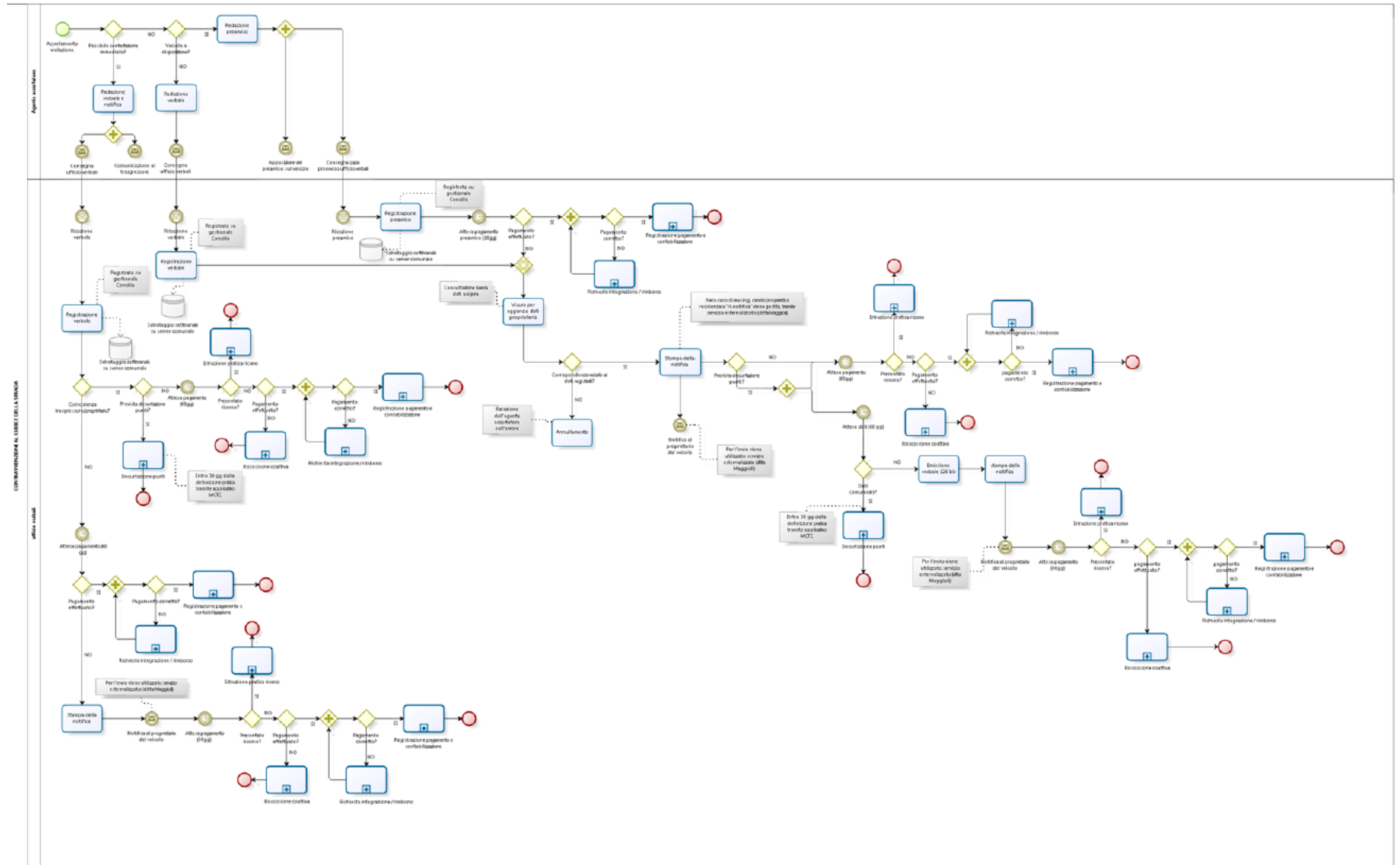



# 1 DIAGRAMMA 1

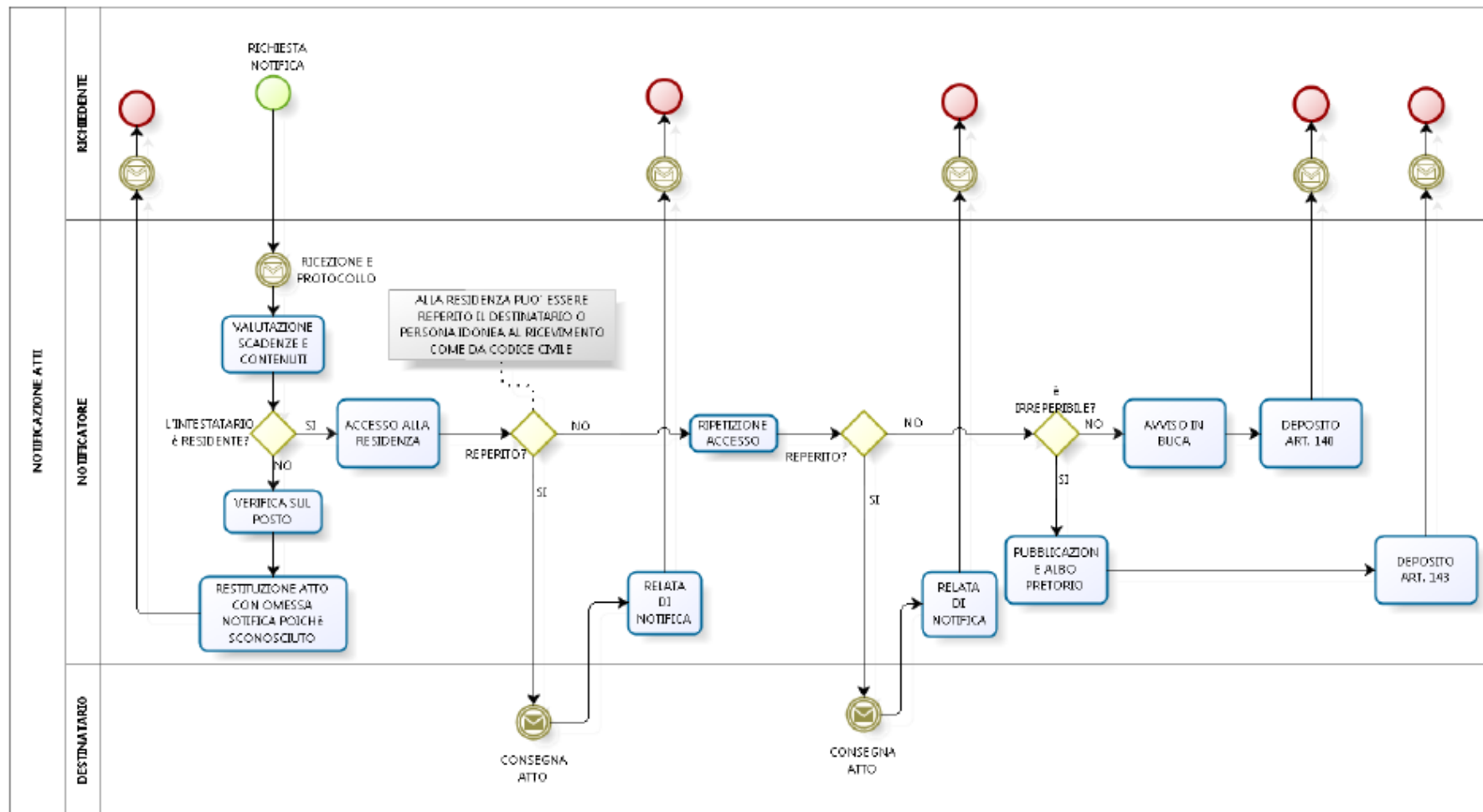

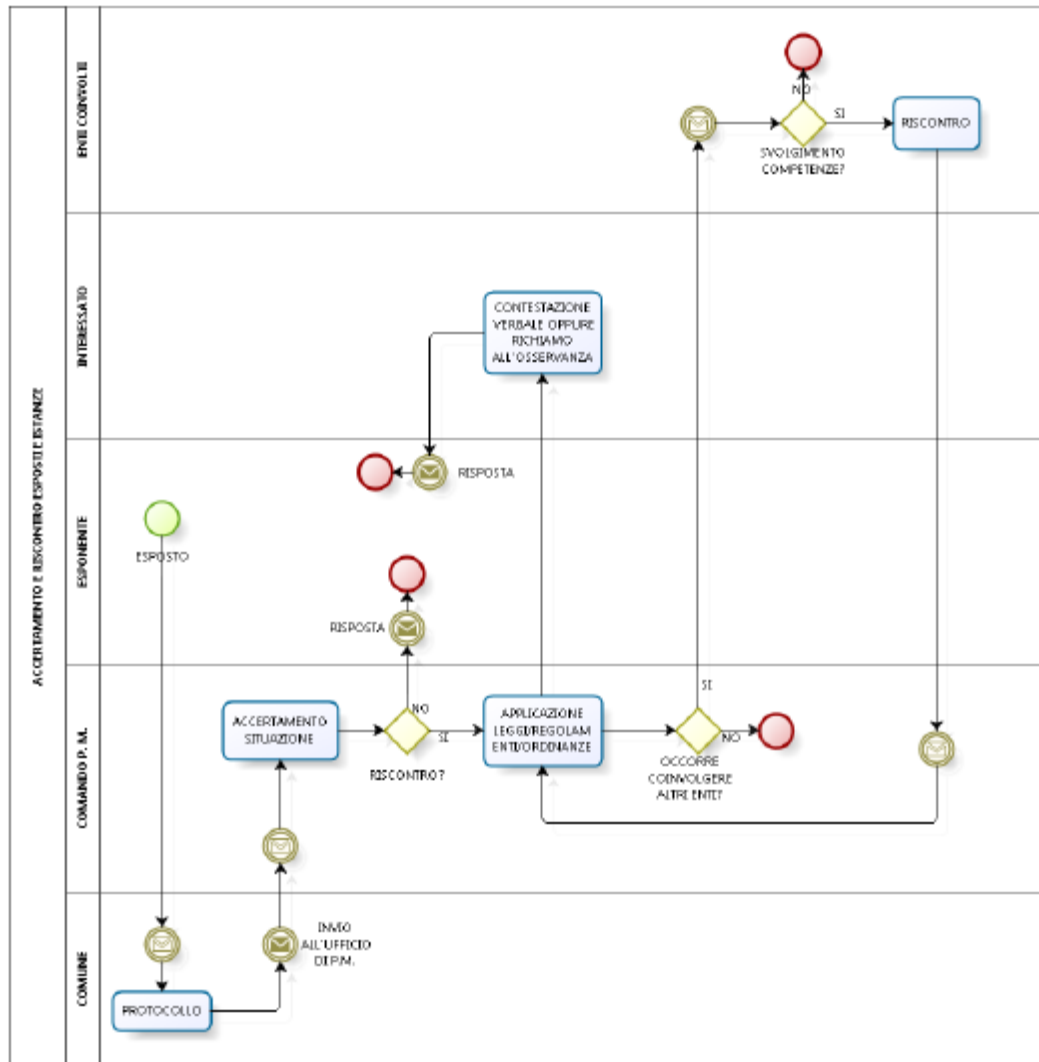

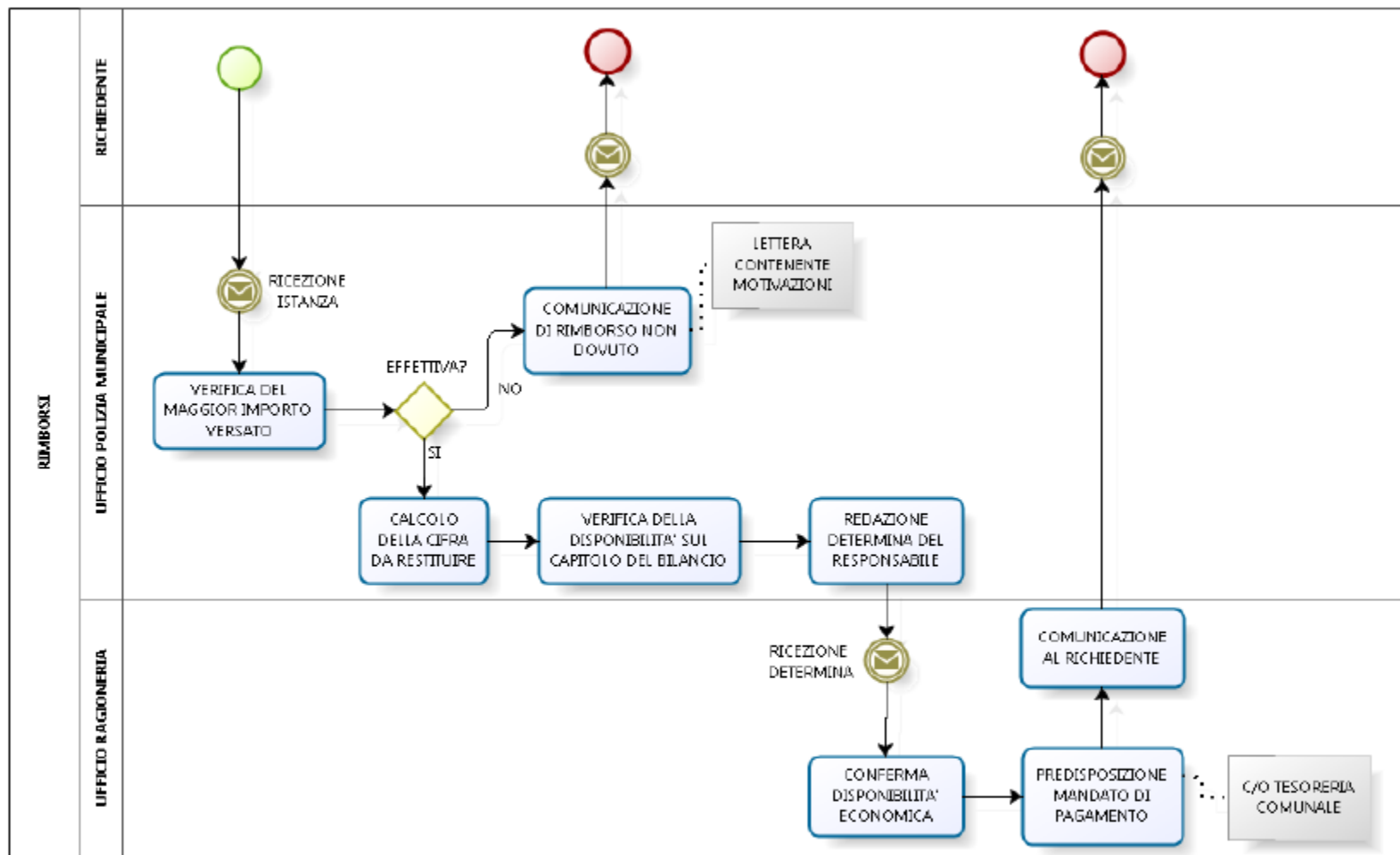

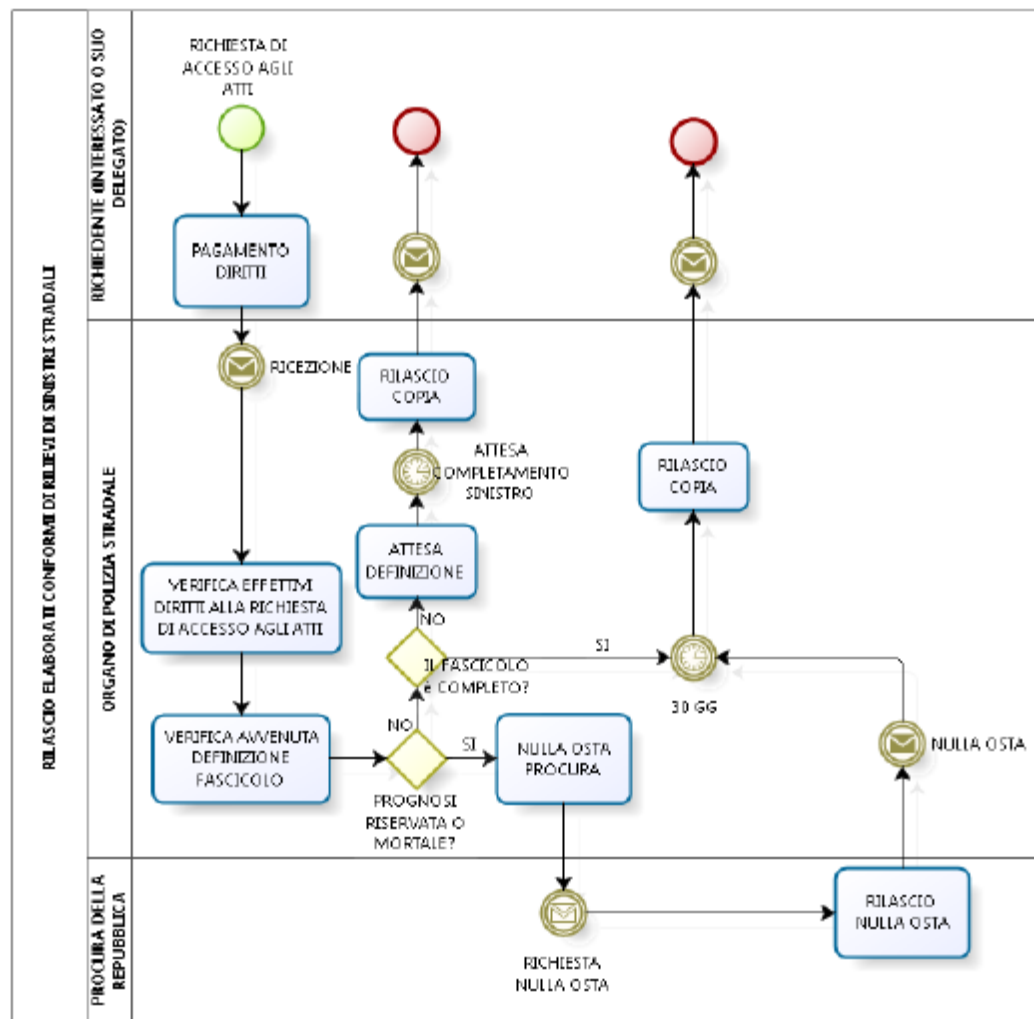

# 1 DIAGRAMMA 1

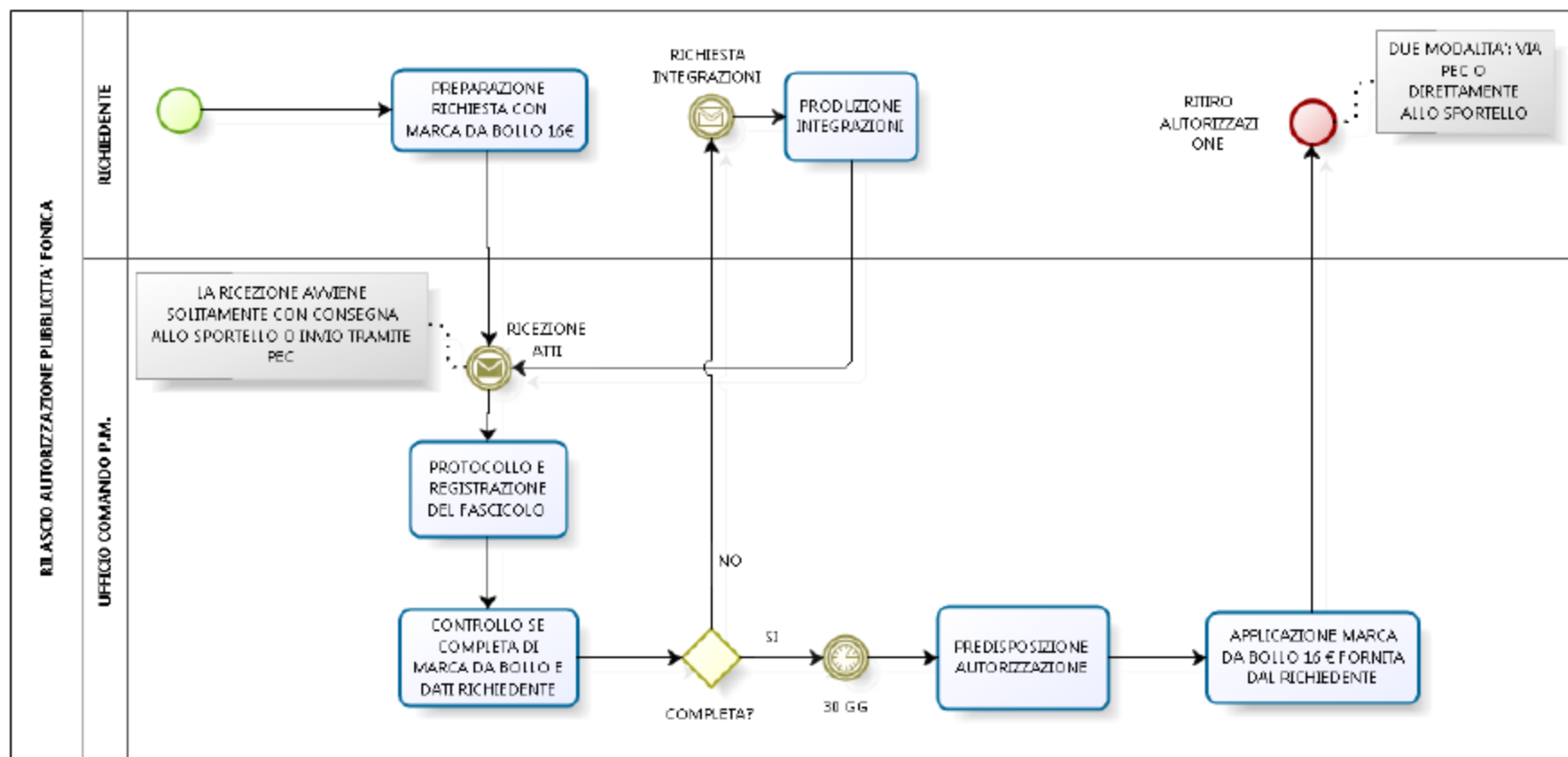

# 1 DIAGRAMMA 1

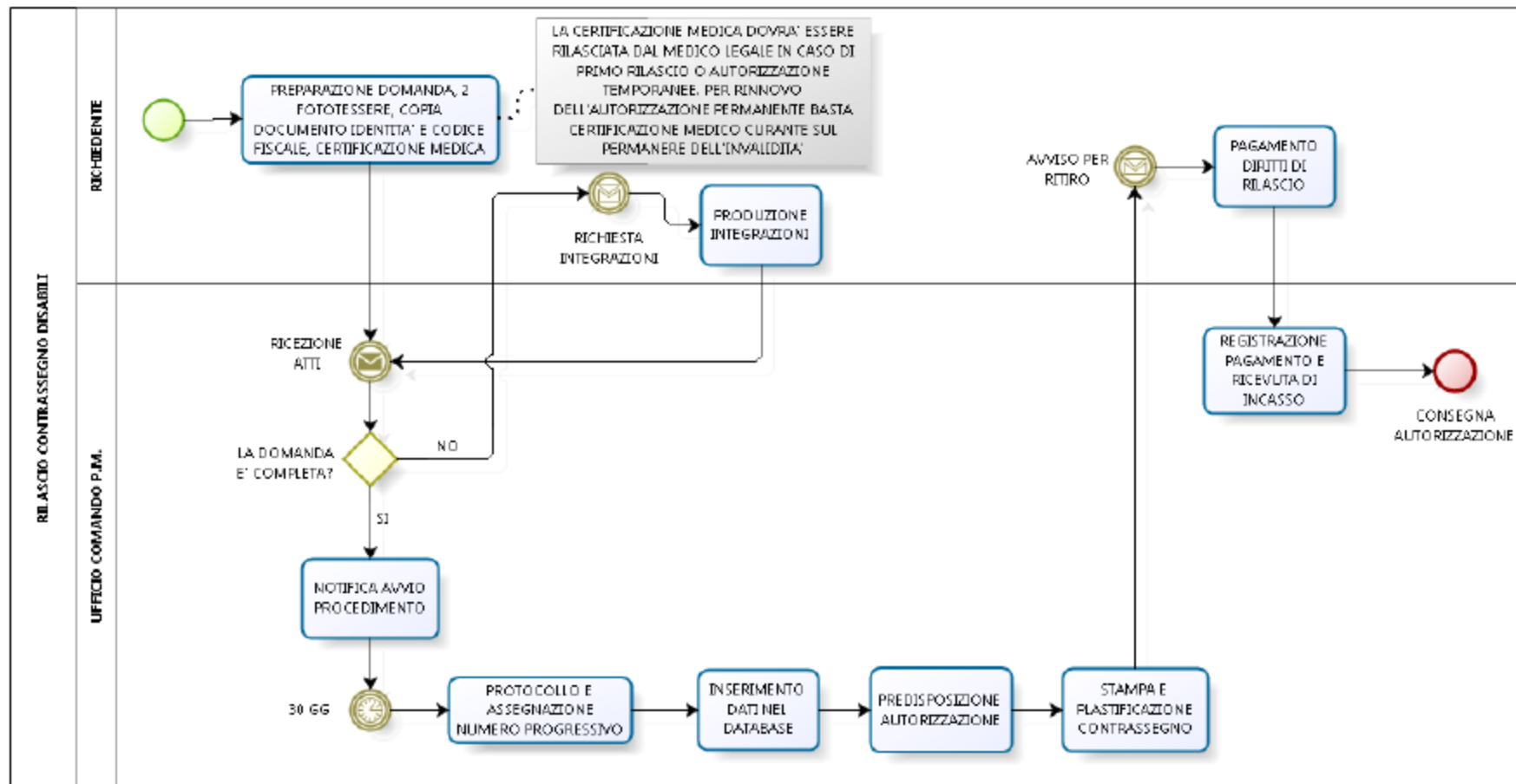

# 1 DIAGRAMMA 1

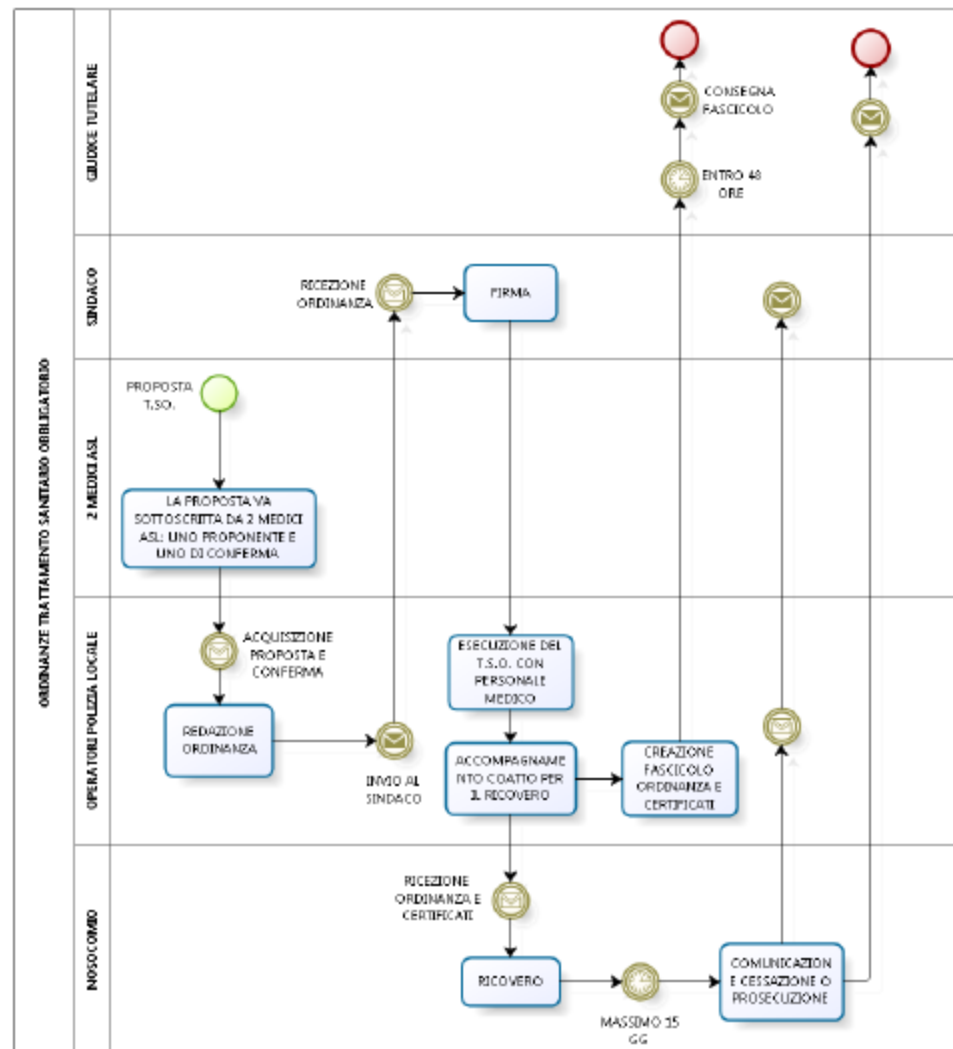

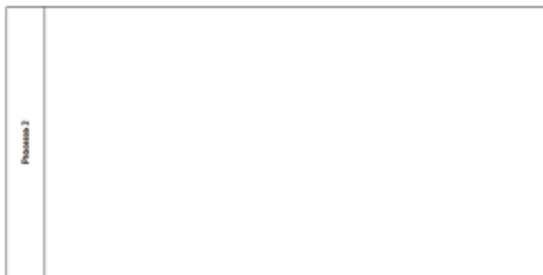
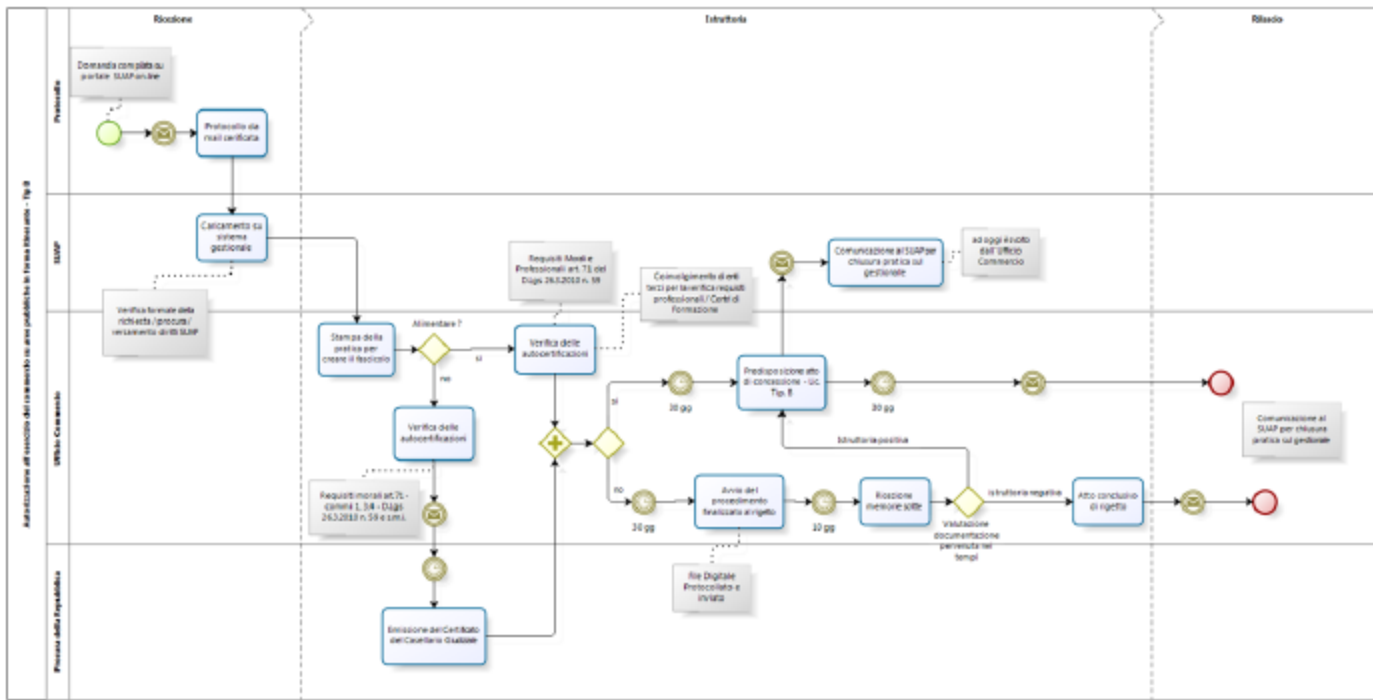



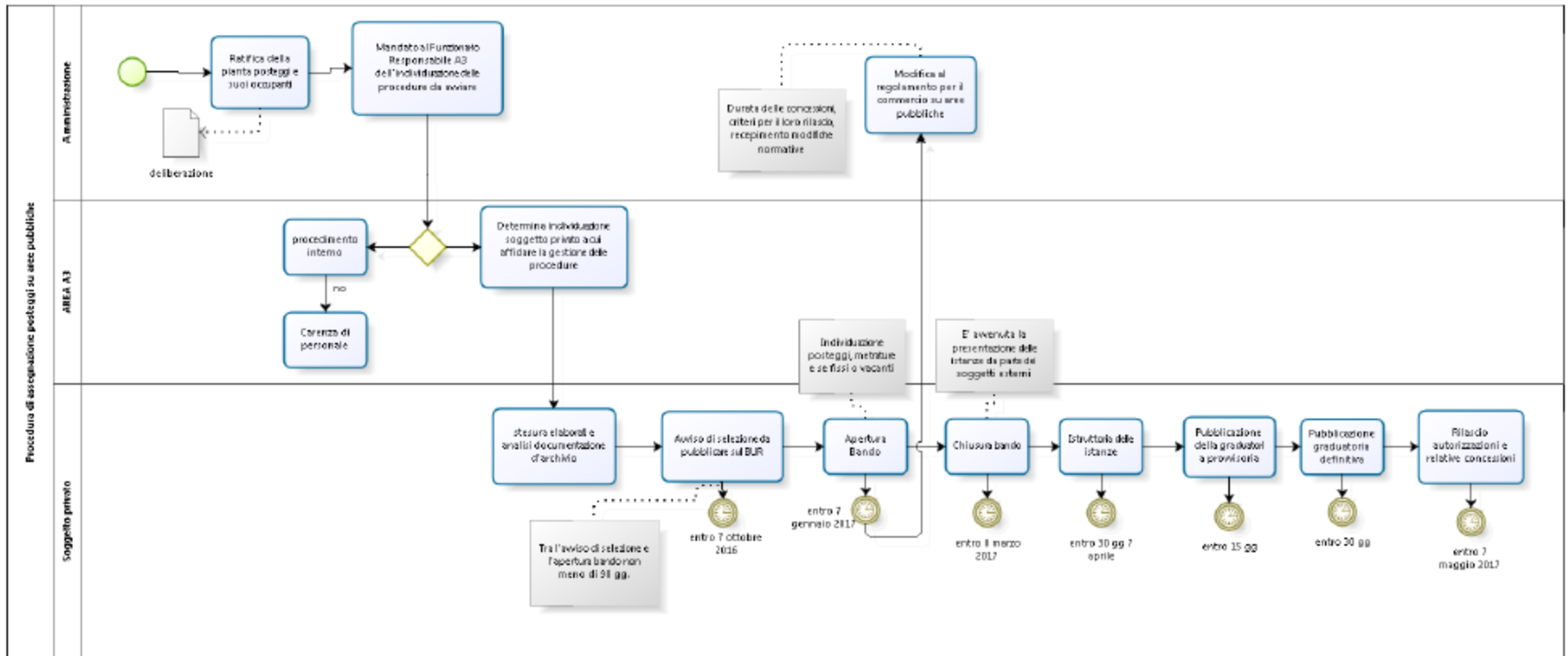

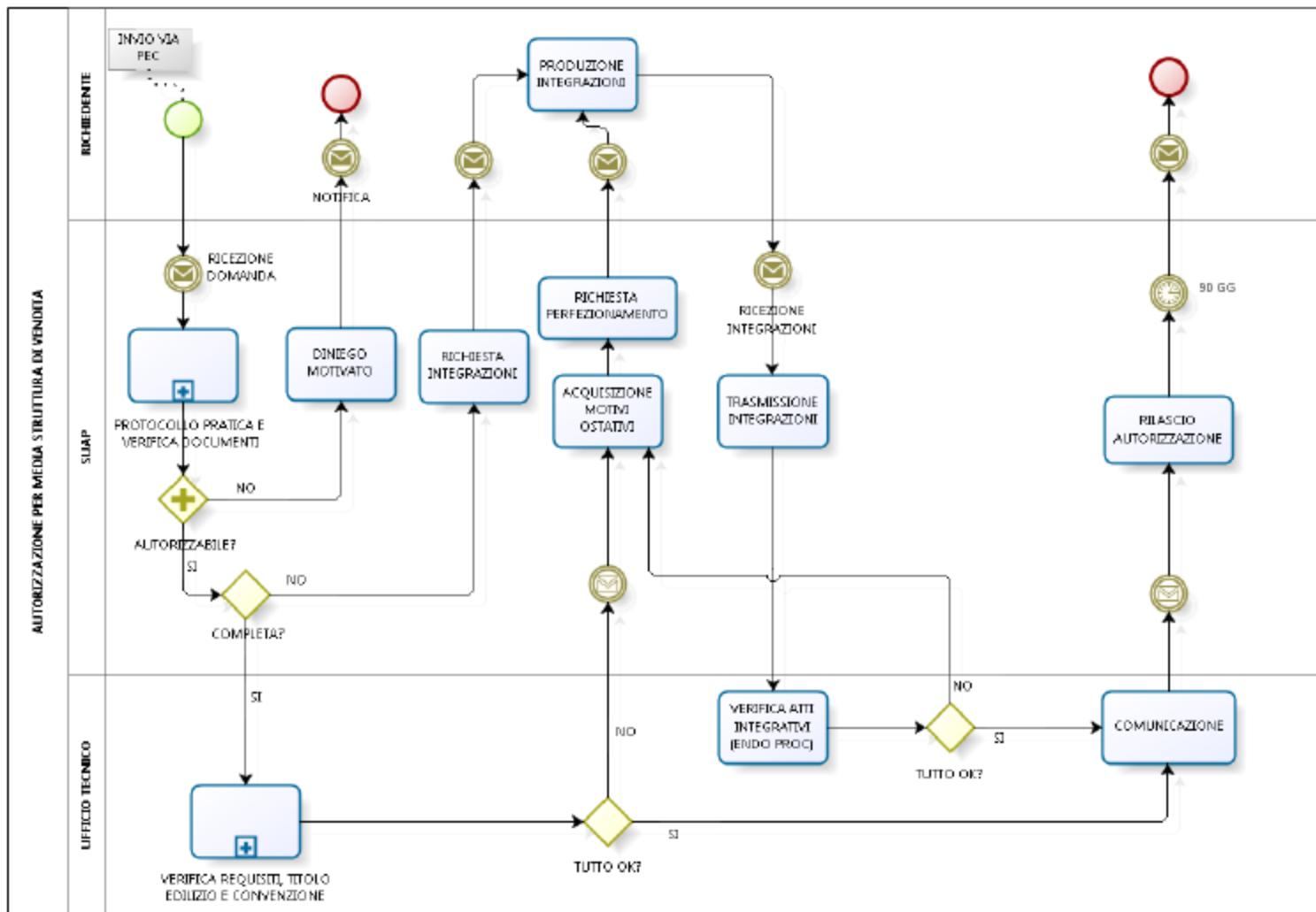

# 1 DIAGRAMMA 1

